

Optimal Syntax¹

JOAN BRESNAN

Stanford University

March 22, 1998

Most OT syntax work to date has taken the OUTPUT to consist of representational simulations of transformational derivations using chains and traces (e.g. Grimshaw 1997; Legendre, Smolensky, and Wilson 1996; Grimshaw and Samek-Lodovici 1996).² The purpose of these notes is to show that there may be advantages, both conceptual and empirical, to adopting a more radically nonderivational theory of GEN, based on a parallel correspondence theory of syntactic structures.

Parallel correspondence theories are familiar in syntax from LFG (e.g. Bresnan ed. 1982, Dalrymple et al. 1995), autolexical syntax (e.g. Sadock 1991), synchronous and unification-based tree adjoining grammars (e.g. Shieber and Shabes 1990, Vijay-Shanker and Joshi 1990), some work in the categorial tradition (e.g. Oehrle 1981), and functional syntactic theories (e.g. Van Valin 1993). They are widely adopted in contemporary nonderivational phonology, appearing in OT phonology in the form of alignment and correspondence theories (McCarthy and Prince 1993, 1995); and they have recently been advocated as the general architecture of UG by Jackendoff 1996. However, they have not yet been integrated with OT syntax. In what follows I will explore how OT fits together with a variant of parallel correspondence syntactic theory based on recent work in LFG (Bresnan 1996 and references therein). Specifically I will develop an imperfect correspondence approach to ‘head movement’ phenomena within OT, and compare it to the framework of Grimshaw 1997, which assumes representations based on serial derivations or their chain-theoretic simulations.

In the example candidate structure of (1) (similar to those adopted in Grimshaw 1997), head movement has taken place in GEN, recorded by an-

¹For valuable comments on earlier versions of this work, I am grateful to Andrew Brendenkamp, Edward Flemming, Jane Grimshaw, Dick Hudson, Scott Myers, Louisa Sadler, Ida Toivonen, Nigel Vincent, Steve Wechsler, and a reviewer for the present volume, though they are not responsible for my use of their comments. The present version will appear in *Optimality Theory: Phonology, Syntax, and Acquisition*, edited by Joost Dekkers, Frank van der Leeuw, and Jeroen van de Weijer, Oxford University Press.

²Notable exceptions include Legendre, Raymond, and Smolensky 1993, Aissen 1998, and Sells 1997.

notating the extended X' structure with a trace (*t*) index coindexed with the verb in I:

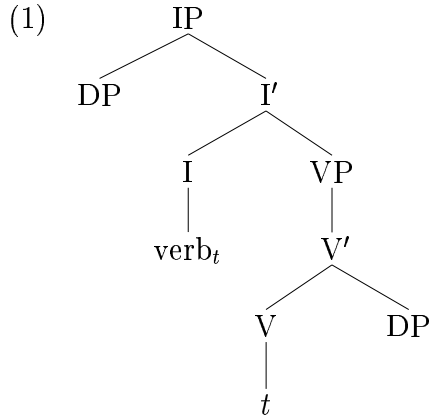

Those syntactic constraints which apply to the initial structure of a serial derivation, prior to movement, are applied to the substructure of the output which preserves information about the initial structure. For example, verbal valence (or θ -grid) requirements must apply to the structure in (1) by using the location of the trace *t* of the verb under V' to satisfy the constraint, not the derived position of the verb under I, which would violate it (because valence satisfaction requires locality to the head). See Grimshaw's 1997 application of the θ -criterion for an example. In contrast, those syntactic constraints which apply to derived structures in a serial derivation, subsequent to movement, are applied only to the substructures of the output which do not express the relevant information about the initial structure. For example, a constraint that determines overt word order must not in general apply to the initial structures in transformational derivations, and so traces must be exempted from it (see for example Grimshaw's Case-Left constraint (1997: 406–7)). Thus, in general, different regions of a single tree structure are placed in correspondence through coindexing (trace) annotations, and are used to satisfy constraints that apply at different points in the serial derivation. The linking or correspondence mechanism across these different subregions of tree structure is the transformation.

Parallel correspondence theory provides a more general model of the same relations. Instead of coindexing a single tree structure with itself, with different subtrees functioning as the domains of different sets of constraints, we coindex two parallel (synchronous, copresent) structures, a categorial structure and a

feature structure in LFG, as illustrated in (2).³ The correspondence between structures is indicated by coindexing in this diagram:⁴

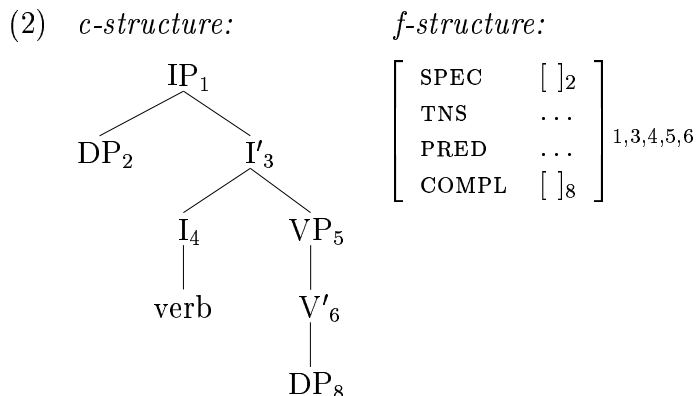

The correspondence function associates each c-structure node with a unique (but not necessarily distinct) f-structure, which is given a numerical subscript in this example. Thus the leftmost DP node is associated with the SPEC f-structure []₂, the rightmost DP node with the COMPL f-structure []₈, and the V and I nodes and their projections are all associated with the outermost f-structure, which bears the multiple subscripts 1,2,4,5,6. Note that in LFG (as in autolexical syntax) the correspondence mapping is imperfect (not being a one-to-one function from domain onto codomain), relates nonhomogeneous structures, and so is formally nontransformational.

The categorial (c-)structure represents the variety of surface forms, showing the order of overt elements; the feature (f-)structure represents language-independent content, including the roles and functions of arguments and predators, abstracting away from their linear order and constituency. This scheme eliminates the problem of stipulating which constraints apply to which points in the derivation, or to which types of constituents in the representational simulations of a derivation: moved or unmoved, projected or unprojected, null or

³Here the attribute SPEC refers generally to the most prominent argument of verbal and nominal categories (the subject and possessor, respectively); the attribute COMPL refers to lexically selected complement arguments such as objects and predicate complements (OBJ and XCOMP in LFG). Other parallel structures are also included in the general theory: semantic structure, prosodic structure, information structure, etc., but I will limit discussion to c- and f-structures in what follows. See Choi 1996 for an analysis of the interactions of information structure and the syntax of scrambling in the present framework.

⁴See Kaplan 1995 for the formal theory of correspondence.

overt, trace or nontrace. For example, because the f-structure lacks information about linear order, constraints on the overt positions of constituents must apply to c-structure; because the c-structure lacks information about predicate argument structure, constraints on valence satisfaction (e.g. Grimshaw's θ -criterion, which corresponds to LFG's Completeness and Coherence conditions) apply to f-structure. Constraints also govern the correspondence between c- and f-structures.

Further results follow from imperfect correspondence. Because the mapping from tree to feature structure is many-to-one, for example, large regions of categorial structure, such as the entire verbal extended projection in (2) including nodes 1 and 5, may be mapped into a single feature structure. This means that in principle the main predicator of a large structure (in (2) this is the verb) can appear overtly in any of the range of different categorial positions for heads that correspond to the same feature structure, while still ensuring satisfaction of its valence requirements. Which positions it actually appears in depends not on movement (the paired structures are generated without movement), but on *correspondence*, by principles discussed below. Correspondence constraints determine how lexical items correspond to categorial structure and how the categorial structure corresponds to the feature structure.

This approach to head movement phenomena, we will see, can explain the generalizations captured under the movement approach and its representational simulations based on chains. Yet it is not a notational variant of the movement approach; it is more general. While movement configurations coindex only one lexically filled position with a chain of empty ones, imperfect correspondence allows for 'coindexing' (formally, a correspondence mapping) between multiple lexically filled positions. Phenomenologically, this means that information from the same feature structure may appear distributed across multiple lexical heads in the categorial structure. Such situations occur in many languages with multiple inflectional exponents of the same morphosyntactic category. For example, tense marking in the Australian language Wambaya (Nordlinger in press) occurs simultaneously on both auxiliary (I) and main verb (V). In Wambaya, the tense values of a clause arise compositionally from the individual inflections on I and V which have overlapping values. Nordlinger and Bresnan 1996 show that the tense system exploits the general theory of imperfect correspondence outlined here, unifying information from different regions of the verbal extended projection.⁵ Thus while the parallel correspondence approach can capture the

⁵Niño 1995 analyzes Finnish negation from this perspective.

valid generalizations modelled by movement, it also encompasses to the merger of information from multiple unmoved heads.

Another aspect of imperfect correspondence is that some feature structures may lack any correspondents in the syntactic tree: the correspondence mapping is ‘into’ but not ‘onto’. The result is the existence of elements which have real functions in syntax but are not expressed as tree constituents: null arguments and other covert elements. The source of feature structures not represented by tree nodes can be the lexicon, the morphology, or the discourse context. A simple illustration is given in (3), showing a Chicheŵa verb under the analysis of Bresnan and Mchombo 1987 (modulo n. 3), and (4), showing an equivalent English clause. As (3) graphically illustrates, in Chicheŵa it is the subject and object morphology of the verbal head (represented by the prefixes *ndi-* and *mú-*) that specifies the pronominal content of the f-structure arguments.

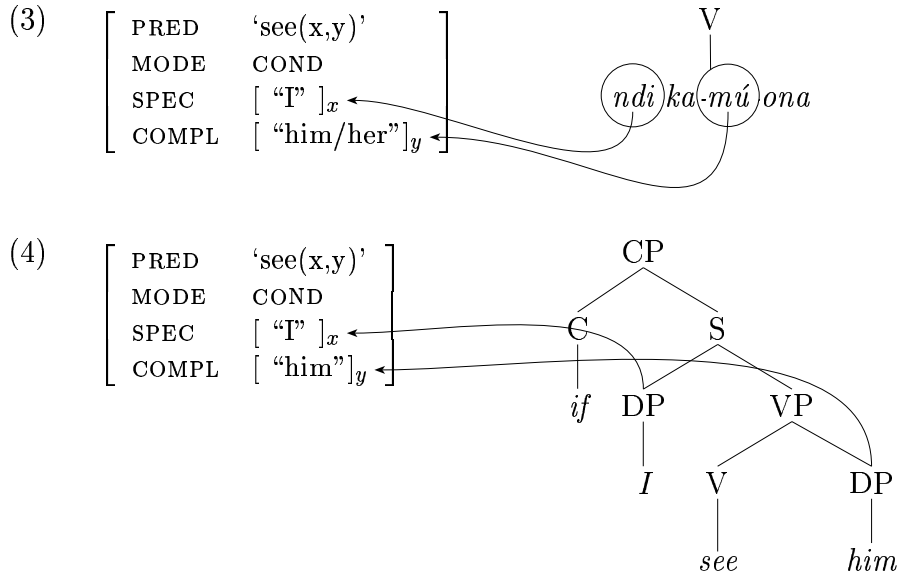

The theory that morphology and the lexicon construct complex feature structures independently of phrase structure has a long tradition within LFG (see Bresnan and Mchombo 1995 for references) and is being developed and exemplified in much recent work (e.g. Börjars, Vincent, and Chapman 1997, Nordlinger 1997, Sadler 1997, Bresnan forthcoming, among others).

Thus in this approach the informational complexity of words may match that of large syntactic phrases without the need to assume that words are dependent on the principles of structural formation of syntactic phrases. Words

may be functionally equivalent to phrases in the sense of corresponding to the same feature structures, yet they exhibit lexical integrity in the sense of being alternative forms of expression constructed from different elements and by different principles of combination (Bresnan and Mchombo 1995, T. Mohanan 1995, Börjars, Vincent, and Chapman 1997, Sells 1995). In a parallel correspondence theory of GEN, therefore, the same feature structure may correspond to candidate expressions arising independently from the morphology and syntax. The resulting competition can give rise to distributional patterns quite atypical of movement, as we will see.

1 Recasting Grimshaw's 1997 Framework

Let us now turn to the work on head movement in OT pioneered by Grimshaw 1997. While Grimshaw advances our understanding of the distribution of heads, there are some drawbacks to her transformational conception of GEN.

First, Grimshaw 1997 rather uncomfortably embeds the transformational framework within the OT framework. GEN includes a transformational derivation, alongside a means of base generating all transformationally derived structures. (In other words, for every transformationally derived candidate, there are isomorphic base-generated candidates with empty categories $[e]$ in place of all traces t .) Derivational information is preserved in the output by distinguishing multiple types of empty heads: t and $[e]$, in addition to $[\emptyset]$ filled by a phonologically null morpheme (as in the SPEC of yes-no questions) and e (a category position being empty because the category is optional and is not present in the tree structure). Although these representational distinctions are widespread in much of contemporary syntax, they are reminiscent of the once widespread use of different types of abstract boundary symbols (+, \$, etc.) in the segment strings of early generative phonology to encode junctures between higher level (nonstring) structures such as morphemes or syllables. In effect, information about non-tree structures (semantic and functional) is being encoded into the syntactic tree. It works because the information projected from the other levels is real, but it is not naturally represented. One indication that this representation is not the most natural is that it requires numerous stipulations to be added to the constraints (such as exempting traces from directionality constraints, or heads in moved positions from the θ -criterion) to ensure their correct application as Grimshaw (1997: 408–9) does.

Secondly, Grimshaw's syntactic analysis of heads includes nonuniformities

in the analysis of their morphological inflections. Grimshaw proposes (382) that “in the English system inflection is morphologically associated with a V (i.e. it is lexically attached to a V head), whereas in French it is syntactically projected as head of a projection”. Surely it would be preferable to account for the different word order properties of English and French verbs without assuming that French inflections are syntactically reified as phrase structure heads while those of English are not. More generally, the syntactic analysis seems to accept the most anti-lexicalist syntactic accounts of inflectional morphology, cheek by jowl with lexicalist versions, the choice depending on the language.

Thirdly, the proposed universal constraint set raises questions of generality. The core constraints (OP-SPEC, OB-HD) reflect real or defensible syntactic generalizations (interrogative words tend to reside in prominent peripheral positions in phrase structure, modelled as SPEC of FP; subject-verb inversion is induced to provide heads for these projections which would otherwise lack them). Yet other constraints seem rather framework-internal, referring to specific mechanisms of the transformational GEN. Should we allow reference to derivational (or more generally GEN) mechanisms at all? Intuitively, constraints should be about linguistic substance, not mechanisms or operations. Thus if we can capture the same generalizations without mechanistic (framework internal) constraints, so much the better.

Finally, there is the question of the generality of the theory of structures. Grimshaw’s theory is narrowly concerned with structural properties of English and a few closely related European languages, and her choice of GEN reflects this. There is no way to capture the idea that morphology competes with syntax: morphologically complete words may carry information functionally equivalent to that carried by complex hierarchical phrase structures and may preempt or be preempted by such structures. As we will see, such competition plays a hitherto unexplained role in English auxiliary inversion.

These considerations motivate work on a reanalysis of Grimshaw 1997, consistent with the aims of her (substantive) theory. I propose to do this by replacing her GEN with an LFG version (Bresnan forthcoming) as an exploratory exercise. The LFG version is well suited to this exploration because (i) it incorporates a lexicalized version of extended X’ theory (which closely matches Grimshaw 1991, 1997) as a typological option; (ii) it derives the effects and the generalizations of head movement from general principles without any movements, (iii) it is completely compatible with a strong form of lexical integrity, (iv) it permits both nonconfigurational and mixed configurational/nonconfigurational language types, (v) due to its parallel, correspondence-

based architecture, it allows a coherent and explicit formulation of certain types of faithfulness constraints in syntax that remain obscure under the derivational approach, and (vi) it can explain distributional patterns that remain unaccountable under movement theories and their simulations. I'll modestly call this version "Optimal Syntax" in what follows.

1.1 The Input

In OT the INPUT requires a more abstract characterization of lexical elements and sentential constituents than the customary starting point for a syntactic derivation in most generative frameworks, which usually includes an enumeration of specific morphemes or language-particular lexical heads. For OT syntax the INPUT must represent morphosyntactic content in a universal, language-independent form. The role of the input is to provide a baseline against which the universal candidate set of possible analyses is evaluated to determine the optimal output. Which of the universally available candidates are optimal for a given language depends only on the ranking of constraints, not on any language-particular differences in input. (This is called the principle of 'richness of the base'; see Smolensky 1996b for recent discussion and references.) Thus a more principled means of explaining language variation is required than simply stipulating morpholexical differences among languages.

Grimshaw says little about what the INPUT is in her theory: for a verbal extended projection it consists of a lexical head and its argument structure, an assignment of lexical heads to its arguments, and "a specification of associated tense and aspect" (376). She gives the sole example input shown in (5):

(5) see(x,y), x=John, y=who

Although Grimshaw uses English words to represent the lexical heads of the input informally, it is evident that a more abstract characterization of the input is required by the principle of richness of the base.

In Optimal Syntax the INPUT for a verbal extended projection will be a (possibly underspecified) feature structure representing some given morphosyntactic content independently of its forms of expression. (5) would be replaced by (6), for example:

$$(6) \left[\begin{array}{l} \text{PRED} \quad \text{'see}(x,y) \\ \\ \text{GF}_1 \quad \left[\begin{array}{l} \text{PRED} \quad \text{'NAMED-}John\text{' } \\ \text{GEND} \quad \text{MASC} \\ \text{NUM} \quad \text{SG} \end{array} \right] x \\ \\ \text{GF}_2 \quad \left[\begin{array}{l} \text{OP} \quad \text{Q} \\ \text{PRED} \quad \text{'PERSON'} \end{array} \right] y \\ \\ \text{TNS} \quad \text{PAST} \end{array} \right]$$

Exactly as in (5), (6) represents the relations of the lexical heads “see”, “John” and “who” to each other and specifies the clausal property of tense; unlike (5) (6) replaces the English-specific lexical heads with structured sets of abstract features representing their morphosyntactic content (insofar as it is systematic) in a language-independent format. Also unlike (5), (6) asserts that the main lexical head has the function of PRED(icator) and that “John” and “who” have underspecified (or generalized) grammatical functions GF.⁶ The differences between (5) and (6) are mainly notational, but (6) has the advantage of belonging to a mathematically well-defined system that has been studied in formal, morphosyntactic, and computational domains. This makes it possible to effectively enumerate the harmonically ordered candidate set for a given input, for example. The desirability of this more abstract conception of the morphosyntactic INPUT is further discussed and exemplified in Bresnan 1997a,b,c.

1.2 The Candidate Set

In OT competing candidates are evaluated as structural analyses of the content specified by the input. For learnability the input must be recoverable from the output (Tesar and Smolensky 1996), either by being contained in the output (Prince and Smolensky 1993) or by being in correspondence with it (McCarthy and Prince 1995), and the output must also contain the overt data of linguistic perception. Thus the candidate set from which the output is selected is subject to seemingly conflicting requirements of being both highly abstract (to contain the language-independent input) and highly concrete and ‘surfacy’ (to contain the perceptible overt data).

⁶The subscripts on GF in (6) are arbitrary; technically, each instance of the symbol ‘GF’ in (6) must be distinct to respect the functional uniqueness axiom on f-structures. Underspecification (or generalization) of attributes can be formalized using Johnson’s 1988 model of attribute names as feature structures.

For Grimshaw, the candidate set of analyses of the input consists of all extended projections (in the sense of Grimshaw 1991) which conform to X' theory.⁷ All nodes are optionally absent from the output.⁸ Hence, nodes may be omitted in the output trees in ways that would violate strict endocentricity in X' theory. For example, a head X node may be omitted from an XP in the output.⁹ These X' structures may be further annotated by indices [t , t_i , e_j , etc.] that represent traces of movement transformations in GEN. Finally, though no reference is made to where or how Logical Form (LF) is generated or accessed in her framework of assumptions, Grimshaw assumes (376) that “competing candidates have non-distinct logical forms”, meaning minimally that they must be truth functionally equivalent.

The version of X' theory Grimshaw adopts for her candidate set is very close to that of recent work in LFG (e.g. Kroeger 1993, King 1995, Choi 1996, Nordlinger 1997, Berman 1996, 1997, Austin and Bresnan 1996, Bresnan 1996, forthcoming, Sadler 1997, Sells 1998). Both functional projections (FP, short for CP, IP, DP, etc) and lexical projections (LP, short for NP, VP, AP, PP) are employed in the theory of (endocentric) c-structures, and all c-structure nodes are optional, unless required by general principles (such as Completeness and Coherence).¹⁰ The main differences are these. First, the extended X' theory of LFG is *lexicalized*, in the sense that every syntactic category X represents a lexical class. In particular, functional categories such as I or C are specialized subclasses of (morphologically complete) words which have a syncategorematic role in the grammar (such as marking subordination, clause type, or finiteness). Hence, nothing ever moves to I or C ; if there is overt evidence for an element occupying a special head position such as I or C , it is base-generated in I or

⁷The extended projections of VP include IP and CP; these are “verbal extended projections”. DP is an extended nominal projection of NP.

⁸Cf. “each node must be a good projection of a lower one, *if a lower one is present*” (376 [emphasis added], 408).

⁹An omitted head is not the same as an empty head $X=[e]$ or a head filled by a phonologically null morpheme $X=[\emptyset]$. An omitted head would vacuously satisfy Grimshaw’s HD-LFT constraint, while the empty heads would violate it. Similarly, a head filled by a null morpheme $[\emptyset]$ would satisfy OB-HD, while an omitted X or unfilled head $[e]$ would violate it. Traces of head-movement behave like null morphemes with respect to OB-HD but like omitted heads with respect to HD-LFT. See Grimshaw (1997: 408–9).

¹⁰Completeness requires that every argument required by a PRED(icator) be present in the f-structure; Coherence requires that every function present in the f-structure be associated with a PRED through identification as an argument or adjunct. See Kaplan and Bresnan 1982, Bresnan and Mchombo 1987, Bresnan forthcoming.

C. Second, the extended X' theory of LFG is *nonderivational*: the effects of movement in X' trees arise from the fact that different c-structure positions may correspond to the same f-structure by general principles of correspondence between parallel structures. In particular, it follows from (7a–c) (from Bresnan forthcoming) that verbal extended projections correspond to the same f-structures as their verbal heads:

- (7) a. *Head principle*:
A c-structure head is an f-structure head.
- b. *Co-head principle*:
A c-structure complement of a functional head is an f-structure co-head.
- c. *Complement principle*:
A c-structure complement of a lexical head is an f-structure complement.

Translated into the LFG formalism (Dalrymple et al. (eds) 1995), (7a–c) can be rendered as in (8a–c):¹¹

- (8) a. Annotate projecting categories (e.g. X, X') in c-structure with $\uparrow = \downarrow$.
- b. Annotate nonprojecting categories in F' with $\uparrow = \downarrow$.
- c. Annotate nonprojecting categories (e.g. X'') in L' with $(\uparrow \text{COMPL}) = \downarrow$.

These principles yield the effects of head movement. For example, in a structure like (9), VP is mapped into the same f-structure as I by the head and co-head principles (7a,b):

¹¹The ‘up’ (\uparrow) and ‘down’ (\downarrow) arrows refer to the unique f-structures respectively associated by correspondence to the mother and the annotated node. Hence ‘ $\uparrow = \downarrow$ ’ means that the f-structure of the mother of the node so annotated is identical to the f-structure of the annotated node. This equation has the effect that the feature structures of heads are merged with those of their projections, an example of the many-to-one nature of the correspondence between c-structure and f-structure. The equation ‘ $(\uparrow \text{COMPL}) = \downarrow$ ’ has the effect that the feature structure of the annotated node is embedded within the COMPL function of the f-structure of the mother node.

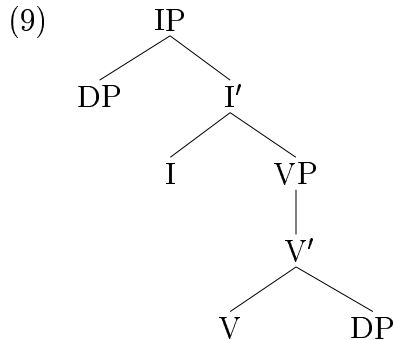

Further, V' is mapped into the same f-structure as VP by (7a), and DP in V' is a $COMPL$ by (7c). If I contains the main verb and V is omitted, the verb's $PRED$ will be satisfied by the $COMPL$ in f-structure. Thus the mapping between the c-structure in (9), V omitted, and its parallel f-structure will look like (10), where TNS and $PRED$ are lexical and morphological features of the verb in I :

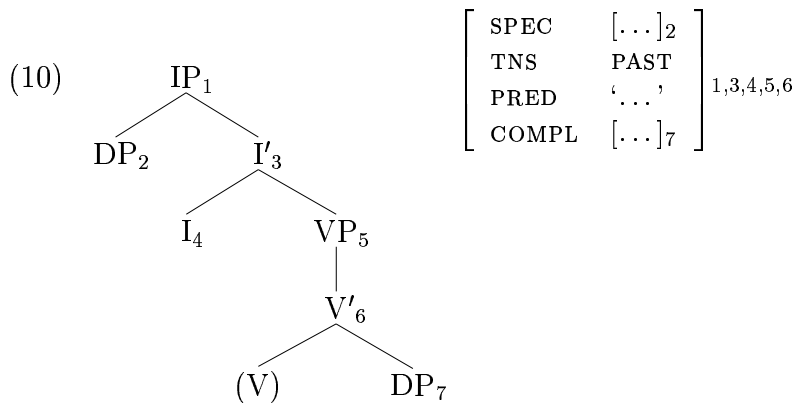

The omission of V is preferred to postulating an empty V because the latter adds no additional information to the f-structure and therefore violates economy of expression (Bresnan 1996, forthcoming). For Grimshaw, base generation of 'movement' configurations like (10) violates the theta criterion, which (as in transformational grammar) is assumed to apply to X' representations. For LFG, as we saw before, the effects of the theta criterion (satisfaction of the argument structure of the $PRED$) are obtained at f-structure, not c-structure. In (10), the $PRED$ and its arguments ($SPEC$ and $COMPL$) all lie within the same f-structure, where completeness and coherence obtain. It is this use of parallel,

copresent structures which obviates the need for a serial derivation in capturing ‘movement’ generalizations.

The third departure of the extended X' theory of recent LFG from that of Grimshaw 1997 is *typological*: the former includes non-endocentric categories and structures. In particular, S is universally available as an exocentric category having no fixed categorial head and projecting no higher category. (Thus, there is no category X such that $S=X^{max}$, and there is no S' .) S may dominate either configurational or nonconfigurational (flat) structures. In the latter instances, grammatical functions are determined not by the X' configuration (as in (7a)–(7c)), but by the morphology (Simpson 1991, Austin and Bresnan 1996, Nordlinger 1997). Configurational S consists of a subject constituent and an XP predicate, which is the f-structure head. A configurational ‘internal-subject’ language (e.g. Welsh according to Sproat 1985, Kroeger 1993, Sadler 1997) would have S under IP, and VP under S:

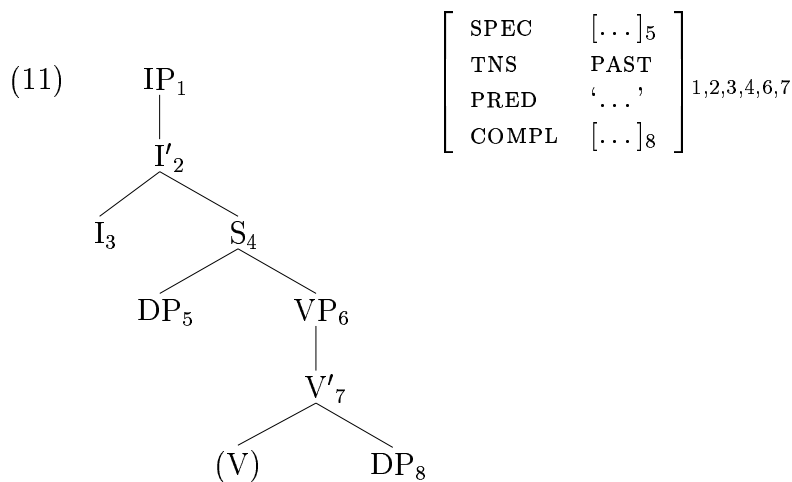

A nonconfigurational subject-internal language (e.g. Warlpiri according to Kroeger 1993, Austin and Bresnan 1996, following Simpson 1991, and Nordlinger 1997) would have S under IP, but no VP:

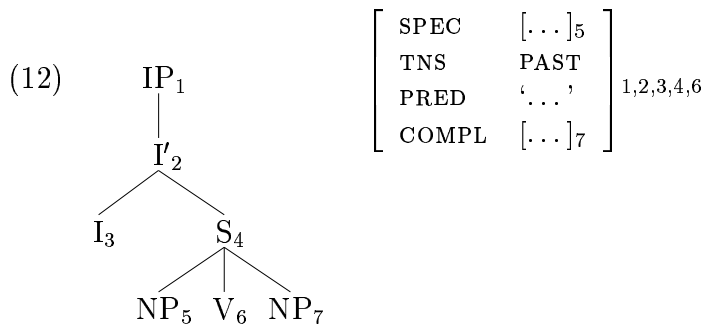

In fact, the main predicator in a Warlpiri sentence can be N; with N predicators, an auxiliary (and hence IP) is optional, yielding a fully nonconfigurational sentence structure S. The functions of the NPs in Warlpiri are determined by principles which associate GFs with case morphology rather than configurations (see Nordlinger 1997 and the references cited there).

Treating S as the category of the ‘internal subject’ solves a number of problems raised by the VP-internal subject hypothesis: if subject is SPEC of VP (as assumed by Grimshaw 1997), then the fact that V’ behaves syntactically like X^{max} is unexplained; if subject is instead adjoined to VP, then a stipulative disjunction is introduced into the definition of SPEC. Kroeger 1993 argues in favor of S and not VP as the category of the internal subject in Tagalog. In the present version of X’ theory, therefore, SPEC of LP is taken to be undefined and VP-internal subjects are actually S-internal subjects.

Note that syntactic evidence cited by Grimshaw (1997: 379) in favor of the VP-internal subject hypothesis in English already follows from the present theory. Because the VP under the above principles always corresponds to the same f-structure as its extended projection, *VP always has an internal subject in the f-structure*. The need to hypothesize a structural subject constituent in c-structure where none is ever overt is an artifact of the derivational representations assumed in movement frameworks.¹²

¹²Burton and Grimshaw 1992 observe that the coordination of active and passive or unaccusative VPs (e.g. *The criminal will be arrested and confess to the crime*) is inconsistent with movement theories of passive and unaccusative if the VP lacks an internal subject position: movement of an underlying object NP to a subject position external to the VP will violate across-the-board constraints on movement from conjunctions; movement to a subject position internal to the conjunct VP will solve the problem. This problem is an artifact of the derivational representational framework: correspondence theories of passives and unaccusatives (e.g. Bresnan and Zaenen 1990, Legendre, Raymond, and Smolensky 1993. Aissen

Under this conception of GEN, the candidates in Optimal Syntax will be multidimensional structures whose components correspond imperfectly. Each candidate is a quadruple consisting of a c-structure, an f-structure, a lexicalization function mapping preterminal nodes of the c-structure into instances of the morpholexical inventory, and a correspondence function mapping each non-terminal node onto a unique (but not necessarily distinct) f-structure. (Other structures in parallel to c-structure and f-structure are disregarded here.)¹³

For a given input such as (13), the universal candidate set will include the (simplified) members illustrated in (14)–(17).¹⁴

$$(13) \quad \left[\begin{array}{l} \text{PRED} \quad \text{'see(x,y)'} \\ \\ \text{GF}_1 \quad \left[\begin{array}{l} \text{PRED} \quad \text{'PRO'} \\ \text{PERS} \quad 1 \\ \text{NUM} \quad \text{SG} \end{array} \right] \quad x \\ \\ \text{GF}_2 \quad \left[\begin{array}{l} \text{PRED} \quad \text{'PRO'} \\ \text{PERS} \quad 3 \\ \text{NUM} \quad \text{SG} \\ \text{GEND} \quad \text{FEM} \end{array} \right] \quad y \\ \\ \text{TNS} \quad \text{PAST} \end{array} \right]$$

Candidate (14) categorizes the finite main verb of English as I rather than V, as Grimshaw 1997 assumes for French (cf. also Netter and Kärcher 1986, Netter 1988, Meier 1992, Frank and Kärcher-Momma 1992, Kroeger 1993, King 1995, Niño 1995, Bresnan 1996, forthcoming, Sadler 1997, Berman and Frank 1996, and Berman 1996, 1997 for similar analyses within LFG).

1998, Sells 1997), already capture these generalizations without movement, by assuming alternative correspondences between argument structures and syntactic functions or case arrays. For example, in the present framework, the f-structure of the VP already includes all of the information needed for the passive voice correspondence between a(argument)-structure and syntactic functions.

¹³On an alternative formalization (cf. Andrews and Manning 1993), the candidates would be trees annotated at the nodes with (partial) feature structures, either lexical or syntactically composed. The correspondence is then the annotation function. I will adhere to the classic LFG formalism here, but this alternative, with its affinities to Construction Grammar and HPSG, is also of interest and completely compatible with the Optimal Syntax framework.

¹⁴These candidates are simplified by omitting X' c-structure nodes dominated by non-branching XP, by omitting the contents of the morpholexical feature structures of the terminals in favor of labelling by their English orthographic names, and by abbreviating the contents of subsidiary feature structures in the global feature structure with double quoted labels.

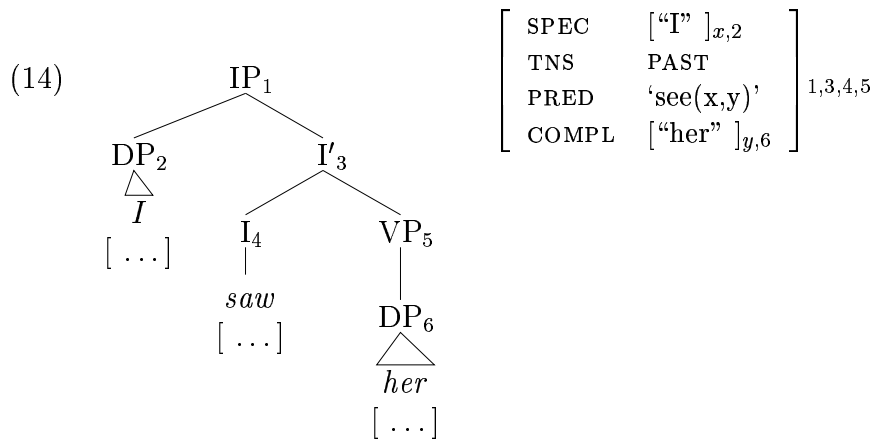

Candidate (15) categorizes the finite main verb as V, as in English:

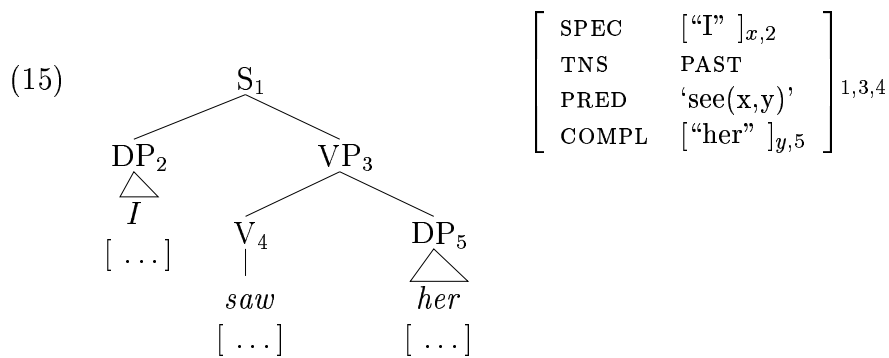

Candidate (16) categorizes the pronominal subject as a verbal inflection—a universally available structural type found in some languages (cf. Bresnan and Mchombo 1987, Demuth and Johnson 1989, Andrews 1990, Börjars, Vincent, and Chapman 1997, Nordlinger 1997 for a range of examples analyzed within LFG). In OT the absence of pronominally inflected verbs from the English inventory must be derived from the ranking of universal markedness constraints on categorization (as in Bresnan 1997a,b,c), rather than stipulated as a morphological feature of the language; it could in fact emerge as a variant structural possibility in English too (cf. Börjars and Chapman to appear).

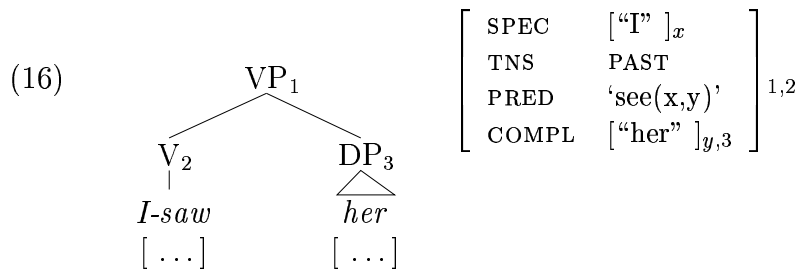

Candidate (17) categorizes the finite main verb as I and maps its co-head to S rather than VP, yielding an internal-subject construction as is found in Welsh and other Celtic languages (see Kroeger 1993, Bresnan forthcoming, Sadler 1997 for LFG analyses).

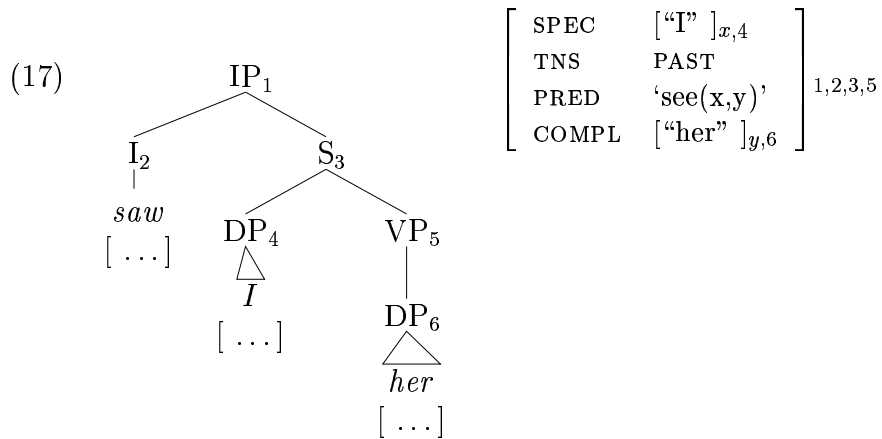

Candidate (18) reflects the non-endocentric c- to f-structure correspondence found in nonconfigurational languages which use morpholexical specification of functions (see Simpson 1991, Austin and Bresnan 1996, Nordlinger 1997 for recent analyses in LFG):

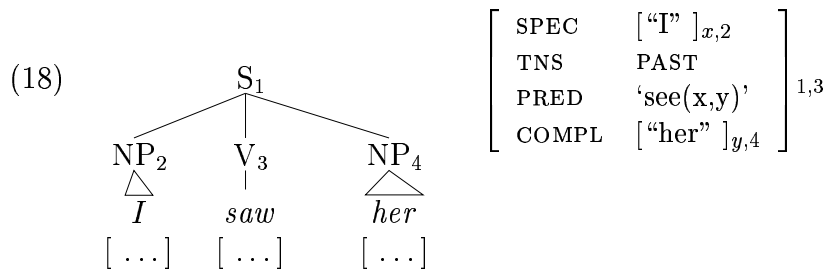

Being infinite, the universal candidate set includes many more realizations of the given content than are illustrated here, as well as many unfaithful candidates with different morphosyntactic content. It is the job of the constraint ranking to select those belonging to a given language.

In sum, where Grimshaw’s 1997 candidate set has X’ structures which encode transformational derivations of the input lexical heads by means of trace indices and which must match some unformalized LF, Optimal Syntax has a typologically richer set of lexicalized tree structures which are indexed to parallel feature structures and matched to the input under correspondence.

1.3 Constraints

On the conception of GEN developed here the INPUT simply represents language-independent morphosyntactic ‘content’ to be expressed with varying fidelity by the candidate morphosyntactic forms, which carry with them their own interpretations of that content (Bresnan 1997a,c). Faithfulness constraints ensure the expressibility of the input content in some possible output form. Correspondence constraints regulate the behavior of the lexicalization function and the mapping from c-structure to f-structure. The optimal candidates represent a balancing of the priority each language gives to expressibility of the input, the uniformity of the form/content correspondences, and the markedness of the output.

Faithfulness constraints require the feature structure of the output to match the input, thus enforcing expressibility of the input content by some form of expression that carries similar content. In the present study, we will simply assume the PARSE and FILL family of constraints from Prince and Smolensky 1993: for each morphosyntactic attribute such as NUM, PRED, and SPEC, there

is a pair of constraints `PARSE-ATTR` and `FILL-ATTR`. Following Grimshaw 1996 we interpret `PARSE-ATTR` constraints to require input feature values to have identical correspondents in the output, and `FILL-ATTR` constraints to require output features to have some value compatible with the input. An application of these constraints is given in Section 3.

Categorization constraints influence the lexical inventory of each language by regulating the association of preterminal categories with various types of featural content. (They are thus constraints on the correspondence between the c-structure and the terminal string produced by the lexicalization function.) For example, Grimshaw’s `NO-LEX-MVT` constraint (“A lexical head cannot move” 374) is recast in the present framework as a constraint on categorization `NO-LEX-IN-F`: it assigns a mark to the lexicalization of a preterminal functional category by an inventory element having lexical content (which we model with the `PRED` attribute). Since constraints are violable, and may be overridden by higher-ranking constraints, this approach allows verbal content to be lexically inserted into a variety of more or less marked preterminal categories such as `V`, `I`, `C`, rather than invariantly inserted into `V` by definition and then moved by serial derivation to accord with observed distribution.

I will assume that the categorization constraints of English classify finite auxiliaries as belonging to a verbal functional category `F` (comprehending `I` and `C` as in Grimshaw 1991), and all other finite verbs as belonging to a verbal lexical category `V`. Verb raising language (such as Russian (King 1995), Finnish (Niño 1995), Welsh (Kroeger 1993, Sadler 1997), or French as assumed by Grimshaw 1997) would classify finite verbs as members of `I`, not `V`. Thus in Optimal Syntax English differs from verb raising languages in the categorization of finite main verbs (as `V` or `I`), not in whether inflections are syntactic heads projecting their own syntactic category, and this difference in categorization can itself be derived from a constraint ranking difference (see below).

Correspondence constraints govern the possible correspondences between the multiple dimensions of the output. Optimal Syntax assumes flexible, imperfect correspondences between the parallel structures representing various linguistic dimensions. Because this approach is not widely familiar I will briefly outline here some of the types of correspondence constraints possible within

this framework.¹⁵

Many of these constraints refer to ‘prominence’, which is defined by ordering relations on c-structure nodes (e.g. c-command), a(rgument)-structure roles (e.g. the thematic hierarchy), and f-structure functions (e.g. the functional hierarchy: TOP FOC SUBJ COMPL ADJUNCT). Syntactic functions are classified into argument/nonargument functions, distinguishing SUBJ and COMPL from the others, and discourse/nondiscourse functions, distinguishing the syntactic functions having special discourse prominence (the DF functions TOP, FOC, and SUBJ) from the rest (Bresnan 1996, forthcoming).¹⁶ Where different prominence relations correspond in such a way as to reinforce each other (prominence on one dimension matching prominence on another), we have instances of harmonic alignment in syntax (Aissen 1998).

(19) (I) **A- to F-structure Correspondence**

- (i) The most prominent a-structure argument corresponds to the most prominent (least oblique) syntactic argument function.
- (ii) The most affected a-structure argument corresponds to the most prominent syntactic argument function.
- (iii) Arguments correspond to the least prominent syntactic argument function.
- (iv) Completeness and Coherence (every function has a role and conversely).

(II) **C- to F-structure Correspondence: Endocentric Constraints**

- (i) Heads correspond to heads.
(A c-structure head is an f-structure head (7a).)
- (ii) LP complements correspond to complements.
(The c-structure complement of a lexical category is an f-structure complement (7c).)

¹⁵These illustrative constraints are based on Bresnan and Zaenen 1990 (cf. Legendre, Raymond, and Smolensky 1993), Bresnan 1996, forthcoming, and much other recent work in LFG.

¹⁶Note that DF functions are *syntactic* functions subject to Completeness, Coherence, and Functional uniqueness, and are not to be equated with communicative functions in discourse, intonationally marked information packaging functions, and the like. DF may be compared to the highest clausal \bar{A} positions in derivational theories. Note also that the SUBJ function is the unique function which is both an argument function and a discourse function (DF).

- (iii) FP complements do not correspond to complements.
(The c-structure complement of a functional category is an f-structure co-head (7b).)
 - (iv) Prominence in the functional hierarchy corresponds to prominence in c-structure.
(The DF functions SUBJ, TOP, FOC are specifiers of functional categories FP.)
- (III) **Morpho-functional Correspondence: Lexocentric Constraints**
- (i) Obliqueness of case corresponds to obliqueness of function (lesser prominence of argument functions).
(A nominative c-structure constituent is an f-structure SUBJ, an accusative c-structure constituent is an f-structure OBJ, etc.)
 - (ii) Agreement corresponds to greater prominence of argument functions. (OBJ agrees only if SUBJ agrees, etc.)

Other constraints include analogues of Grimshaw's 1997 constraints discussed in detail in the next section, and a constraint on syntactic phrase structure requiring it to contribute nonredundant information to the f-structure. The latter constraint, proposed as a principle of LFG in Bresnan 1996 and forthcoming, is variously referred to as a principle of functionality of structure or economy of expression: *all syntactic phrase-structure nodes are optional and are not used unless required by independent principles*. The principle favors morpholexical expression by penalizing phrasal nodes in favor of terminals and preterminals. Here we call it DON'T PROJECT:

(20) DON'T PROJECT: Avoid phrase structure.

Note that the 'unless' clause and the stipulation of optionality in the LFG formulation are unnecessary in the Optimal Syntax version: the exceptions to the principle follow from whatever constraints dominate (20) in the constraint ranking; these will include, for example, the very highly ranked Completeness and Coherence constraints (19)(I)(iv).

As a highly endocentric language, English ranks the endocentricity constraints (19)(II) higher than DON'T-PROJECT. This ranking will make outputs like (14), (15) and (17) more harmonic than (16) and (18).

In the next section I will translate Grimshaw's 1997 theory into the present framework of Optimal Syntax. I will focus just on constraints that correspond

to Grimshaw's and assume the same constraint ranking that she does. Equivalents of several other constraints she hypothesizes will be added later.

2 Deriving Grimshaw's results

Given the framework outlined in the preceding sections, it is not (too) difficult to derive Grimshaw's 1997 results. There are certain systematic differences between the two accounts to take note of, which generally stem from the more 'surfacy' X' theory adopted in Optimal Syntax.

First, in what follows, wherever one of Grimshaw's output structures has a VP with an overt internal subject, we have S, distinct from IP. This is because VP is defined within our X' theory to be a category that does not dominate a subject constituent (Bresnan 1982, forthcoming, Bresnan and Zaenen 1990, Kroeger 1993). C-structural subject positions appear only in SPEC of FP and S; SPEC of LP (for lexical categories XP, including VP) are undefined.

Second, wherever Grimshaw has an optimal structure containing a head-movement trace which prevents a violation of OB-HD, we have the structures lacking them. Such empty heads can of course be generated by GEN, but they are completely redundant, adding no information to the f-structure that is not already captured by the C- to F-structure Correspondence constraints; Economy of Expression (DON'T-PROJECT) therefore renders them less harmonic than the same structures with the empty heads omitted (cf. Bresnan 1996). (Nevertheless, in displaying candidates in tableaux, we will sometimes use an *e* as Grimshaw does to disambiguate the intended structural analysis.)

Let us turn now to the problem of formulating OB-HD in our parallel correspondence framework. As observed in the preceding, there is not a perfect correspondence between the categorial (c-structure) head and the functional (f-structure) head. One case where c- and f-structure heads show imperfect correspondence, as we have seen, is S. Though S has no fixed categorial head from which it must be projected, it has an f-structure head, which provides its PRED attribute (this would be the XP in a configurational language, but could be a lexical category X in a nonconfigurational language (Simpson 1991, Kroeger 1993, Austin and Bresnan 1995, Nordlinger 1997)). Another case where correspondence of heads fails is in functional projections, because of the co-head principle (19)(II)(ii). Now consider the implications of this imperfect correspondence for the formulation of the obligatory head principle OB-HD:

- (21) OB-HD: every projected category (X' , X'') has a lexically filled head.

Suppose we took a narrowly local categorial definition of ‘head’ in determining violations of OB-HD. Looking at a category X' , we would ask: does it immediately dominate a lexically filled category X ? ‘Yes’ would pass OB-HD; ‘No’ would incur a mark. But this is not equivalent in substance to what Grimshaw 1997 does. For Grimshaw, a violation of OB-HD is incurred if X' does not dominate a lexically filled category X *or the trace of a lexically filled category* (see n. 9). Thus, Grimshaw crucially distinguishes examples like (22a) and (22b) (Tableau 1, 378):

- (22) a. $[_{CP} \text{ what } e [_{IP} \text{ DP will } [_{VP} \text{ read } [e]]]]$
 b. $[_{CP} \text{ what will } [_{IP} \text{ DP } e [_{VP} \text{ read } [e]]]]$

If the e in IP in (22b) is interpreted as a trace of verb movement, only (22a) incurs a mark from OB-HD, because of Grimshaw’s assumption that GEN allows only upward movements. Here we see a crucial point of dependence of Grimshaw’s constraints on her derivational conception of GEN. OB-HD is violated in just those structures which lack a lexically filled head at some point in the transformational derivation; her disjunctive definition arises from the translation of this derivational generalization into a representational simulation with chains of coindexed traces. How then should we define ‘head’ in a nonderivational version of this constraint?

It turns out that this question has already been addressed in LFG in other contexts (M. Jar n.d., Zaenen and Kaplan 1995: 221–2). Because of the imperfect correspondence between c-structure and f-structure, the head of a constituent cannot in general be fixed in a unique structural configuration (indeed, this is why variable head positioning can occur at all, within the present framework); but the head can be recovered from looking at the inverse image of the constituent’s f-structure under the correspondence mapping. Within the inverse image of $\phi(C)$ (that is, within the set of constituents that are mapped into the same f-structure as C by ϕ) will be all of the constituents that contribute to C ’s f-structure. In the c-structure theory adopted here, this inverse image will contain the entire extended projection of a constituent, including all of the higher functional heads. One of these higher elements can be identified as the head of a locally headless phrasal category if it matches the categorial features of the latter (Jar n.d., Zaenen and Kaplan 1995: 221–2):¹⁷

¹⁷I have added the “dominates” clause in (23) to restrict the inverse image to upwards regions of structure, corresponding to Grimshaw’s assumptions and to the deeper general-

- (23) X is the **extended head** of Y if X is the lowest node Z such that (i) Z corresponds to the same f-structure as Y, (ii) Z shares the categorial features of Y, and (iii) every node other than Y that dominates Z also dominates Y.

This definition allows the head to count as an extended head of its own category. Thus (23) is equivalent to saying that X is an extended head of Y if X is the categorial head of Y, or Y lacks a categorial head but X is the closest element higher up in the tree that looks and functions like a head. The inverted modal *will* in C position in (22b) is the extended head of C' (assuming with Grimshaw 1991 that functional categories have lexical categorial features, verbal in this case). By (23), *will* is also an extended head of I': first, through the correspondence constraints (19)(II)(i),(iii), *will* corresponds to the same f-structure as the I'; second, because modals are verbal functional heads F in English, occurring in both I and C (inverted) positions, *will* is of the same category type as I'; third, *will* occurs in the upwards extended projection of I', IP, in that there is no category that dominates C and does not dominate I', IP. In contrast, *will* in (22a) cannot be the extended head of C', because IP dominates *will* and does not dominate CP. Finally, by (23iii), *will* in (22b) cannot be the extended head of V' because though it meets conditions (i)–(iii), V is a lower node that meets the same conditions.

A rather different example of an extended head in this framework is the filler of a *wh*-gap. In both (22a) and (22b) the gap [e] corresponds to the same f-structure as the *wh*-phrase head *what*, which has the correct category type and position to be an extended head of the [e].¹⁸ Thus one way to think of an extended head is to imagine it as one of the parts of a discontinuous constituent in the c-structure that are put back together (unified) into a single f-structure.

Let us interpret 'head' in the OB-HD constraint to refer to 'extended head' in the sense just explained. We now get very close to Grimshaw's results. In fact, with this definition, we can state a parallel-correspondence version of STAY:

- (24) STAY: Categories dominate their extended heads.

ization that variable head positioning, being marked, appears only in prominent positions of the tree. This result should be derived from the constraint theory itself, but is treated definitionally in the present exploratory study.

¹⁸Gaps are not uniformly represented by empty categories in the LFG framework. They arise only where there are no other means than phrase structure configuration for the identification of syntactic function (Bresnan, 1996, forthcoming; Choi, 1996; Berman, 1997), and in some LFG frameworks they are absent altogether (Kaplan and Zaenen, 1989).

This constraint is not equivalent to OB-HD (see above), because OB-HD specifies that the head (of a projecting category X' , X'') must be lexically filled; it does not say where the head is. STAY says where the head is.

Those of Grimshaw's constraints that make reference to 'heads' including traces of heads can now be reformulated in terms of 'extended head'. For example, Grimshaw assumes two constraints SUBJ and CASE which regulate the positions in which subjects can appear with respect to their heads (390). We can derive the substantive effects of such constraints as well, e.g.:

- (25) AGR: A subject and its predicate in c-structure agree.
(i.e. A c-structure subject requires that its sister constituent have an agreeing extended head.)

This constraint usefully distinguishes between the following examples. In (26a,b) the subject *she* is sister to a VP whose head (hence, extended head) agrees in (a) and does not in (b).

- (26) a. She [_{VP} wants what]?
b. *She [_{VP} want_{infin} what]?

In (27a,b) the subject is now sister to an I' whose extended head (the inverted auxiliary) agrees in (a) and does not in (b).

- (27) a. What does [_{IP} she [_{VP} want_{infin}]]?
b. *What do_{infin} [_{IP} she [_{VP} wants]]?

Here are the constraint rankings that will be operative in deriving Grimshaw's results, assuming the new definitions of OB-HEAD and STAY. Some of the constraints from the latter part of Grimshaw 1997, such as PURE-EP, aren't included, but fit in completely transparently. The constraint ranking follows Grimshaw 1997.

- (28) Constraint ranking (in descending order of dominance):
- | | |
|------------|--|
| CC | [Completeness and Coherence, as in (19)(II)(iv)] |
| OP(-SPEC) | [defined below] |
| *LEX-F | [defined below] |
| OB-HD | [assuming definition of ‘extended head’ in (23)] |
| AGR | [(25)] |
| FULL(-INT) | [Full Interpretation; discussed below] |
| STAY | [as in (24)] |

Completeness and Coherence are assumed to be undominated. I will omit them from the following tables, and also *LEX-F until it comes into play.

This reconstrual of ‘head’ yields optimal structural analyses isomorphic to Grimshaw’s, as we are now in a position to demonstrate.

Matrix interrogatives and declaratives. For the case of matrix interrogatives and declaratives shown in (29) (based on Grimshaw’s (1)–(2), 377), Grimshaw’s basic explanation is this: OP-SPEC requires that a *wh*-operator be in a specifier position c-commanding the entire extended projection (379), OB-HD requires that the projection of this specifier have a lexically filled head, and both of these constraints outrank STAY, which penalizes movement. Hence, violating them is worse than displacing a constituent by movement.

- (29) a. They will read something.
 b. *Will they read something. (ungrammatical as declarative)
 c. What will they read?
 d. What they will read?

It follows that (29c) will be optimal among the interrogative candidates (29c–d), because even though it violates STAY twice compared the the single violation of (29d), it has both its *wh*-operator in SPEC of CP and its CP head lexically filled by the auxiliary (unlike (29d)); the alternatives incur worse violations than the STAY violations incurred by the optimal candidate.¹⁹ In declaratives,

¹⁹A further piece of the argument is that a base-generated complementizer cannot fill the CP head position without violating another constraint formulated expressly against just this possibility (HD-LFT, 408).

in contrast, no higher functional projection is needed because no operator is present and OP-SPEC is vacuously satisfied. The violation of STAY then emerges to render auxiliary inversion (29b) less harmonic and the uninverted structure (29a) optimal.

An undesirable consequence of this analysis, on which Grimshaw 1997 is silent, is that an *in situ* question like (30) is not optimal compared to (29c), because it violates OP-SPEC; hence it is ungrammatical:

(30) They will read what?

Yet of course the sentence is perfectly grammatical. How can this fact be explained given Grimshaw’s logic? If (30) competes with (29c), it should always lose by violating OP-SPEC. The answer, I believe, comes from considering the role of the input.

Though they always compete against each other in the universal candidate set, matrix interrogatives and declaratives are both grammatical because they differ in content: each is more faithful to a different input, as illustrated by the respective inputs shown in (31a,b):

(31) (a) $\left[\begin{array}{ll} \text{PRED} & \text{'read(x,y)'} \\ \text{GF}_1 & [\text{"they"}]_x \\ \text{GF}_2 & [\text{"what"}]_y \\ \text{TNS} & \text{FUT} \end{array} \right]$ (b) $\left[\begin{array}{ll} \text{PRED} & \text{'read(x,y)'} \\ \text{GF}_1 & [\text{"they"}]_x \\ \text{GF}_2 & [\text{"something"}]_y \\ \text{TNS} & \text{FUT} \end{array} \right]$

Despite the fact that the matrix declarative (29a) incurs fewer violations than (29c) of the constraint STAY, its fatal defect in comparison to the interrogative candidate is unfaithfulness to the interrogative input (31a).

Now one might be tempted to consider the *in situ* question construction (30) simply to be an optional variant of the fronting question construction (29c), drawing on recent developments in the treatment of optionality in OT (as discussed in Bresnan 1997b: e.g. Anttila 1997, in press; Boersma 1997). However, there is evidence that (29c) and (30) are not optional variants, but differ in content in some way. As shown in (32) a class of intensifiers is possible only with the fronted *wh*-phrase (Brame 1978: 21–2):

(32) a. Who the hell/on earth/in the world/in God’s name is he talking about?
 b. He is talking about who (*the hell/*on earth/*in the world/*in God’s name)?

These intensifiers are clearly constituents of the *wh*-phrase; (33) shows that one can occur in each of two coordinated *wh*-phrases:

(33) How on earth and why in God’s name did he do it?

Yet the intensifiers can only appear in the *wh*-constituents when fronted. These facts suggest that some additional feature distinguishes the fronted and *in situ* *wh*-question constituents, allowing for these intensifying expressions.

Following recent work on extraction constructions in LFG (Kroeger 1993, Bresnan 1996, forthcoming, Berman 1997a,b), we can identify the feature as one of the DF functions. These are the most prominent functions on the functional hierarchy (FOC, TOP, SUBJ), and in endocentric languages they are generally associated with c-structure positions that iconically express this prominence, such as the SPEC of FP. See (19)(II)(iv). This gives us two distinct types of interrogative inputs, having the same content except for the additional attribute DF in (b), representing syntactic prominence of the interrogative constituent (b):

(34) (a) $\left[\begin{array}{ll} \text{PRED} & \text{'read(x,y)'} \\ \text{GF}_1 & [\text{"they"}]_x \\ \text{GF}_2 & [\text{"what"}]_y \\ \text{TNS} & \text{FUT} \end{array} \right]$ (b) $\left[\begin{array}{ll} \text{PRED} & \text{'read(x,y)'} \\ \text{GF}_1 & [\text{"they"}]_x \\ \text{GF}_2 & [\text{"what"}]_y \\ \text{DF} & \nearrow \\ \text{TNS} & \text{FUT} \end{array} \right]$

According to this analysis the two inputs differ in their morphosyntactic content, one specifying that the f-structure for *what* is syntactically marked for prominence (as a DF), the other not (intonational marking may be used instead). The fronted question (29) corresponds most faithfully to (34b); the *in situ* type (30), to (34a). We now interpret Grimshaw’s OP-SPEC to require that an operator must be the value of a DF in the f-structure (as well as, possibly, the value of another GF). Faithfulness to the input must dominate OP-SPEC. Then for input (34a) the optimal candidate will be (30), because it will lack the DF attribute present in (29c), and fidelity to the input will mark the latter as less harmonic. This motivates our LFG-style interpretation of the constraint OP-SPEC, which we adopt for concreteness in what follows.

For the input (34b) the optimal candidate is illustrated in (35) (see (36)):

(35)

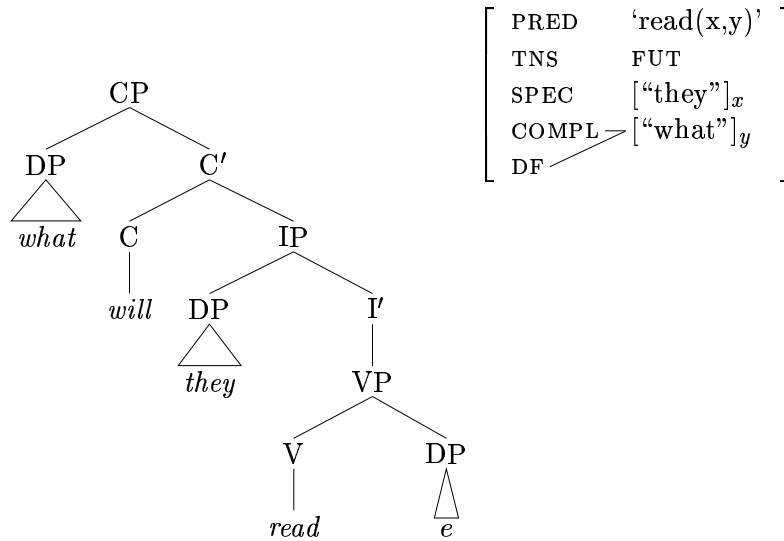

(36) Tableau 1: Matrix interrogatives:

CANDIDATES:	OP-SPEC	OB-HD	AGR	FULL	STAY
i [IP DP will [VP read what]]	*!				
ii [CP e [IP DP will [VP read what]]]	*!	*			
iii [CP what e [IP DP will [VP read [e]]]]		*!			*
⇒ iv [CP what will [IP DP e [VP read [e]]]]					**
v [CP what will [S DP [VP read [e]]]]			*!		*

Grimshaw 1997 rules out candidate (i) by OP-SPEC, and we have followed her analysis here for purposes of comparison; however, in the present framework the candidate also violates the even more highly ranked constraint of faithfulness to the input because it lacks the DF attribute discussed above. Notice that candidate (iii) and not (iv) violates OB-HD. This follows from the considerations just given concerning extended heads. Further, if we did not have the AGR constraint, then (v) would be optimal, because there is no STAY violation in generating *will* outside of S, as opposed to an empty-headed IP. AGR, however, rules out (v): the nonfinite verb in the VP of (v) is the extended head of its VP; since it does not agree with the subject (being an infinitive), there is a violation of AGR. Although Grimshaw does not include a structure like (v) in her candidate set in (Tableau 1) (378), she does in fact rule out an exactly equivalent structure, in which the modal *will* is base-generated in C position, with the subject internal to VP:

(37) [_{CP} what will [_{VP} DP read *t*]]

This candidate is ruled out by her SUBJ and/or CASE conditions, which license subjects only in the right positions with respect to heads (see her definitions, 390). Our constraint that subjects agree with the extended heads of their sister predicates (25) has the same substantive effect.

Grimshaw's results on matrix declaratives (her examples (1a,b)) also follow straightforwardly from these constraints:

(38) a. They will read some books.

b. *Will they read some books. (ungrammatical as declarative)

The input is shown in (39):

(39) INPUT = $\left[\begin{array}{ll} \text{PRED} & \text{'read(x,y)'} \\ \text{GF}_1 & [\text{"they"}]_x \\ \text{GF}_2 & [\text{"some books"}]_y \\ \text{TNS} & \text{'fut'} \end{array} \right]$

A nonoptimal candidate ((iii) in (41)) is illustrated in (40):

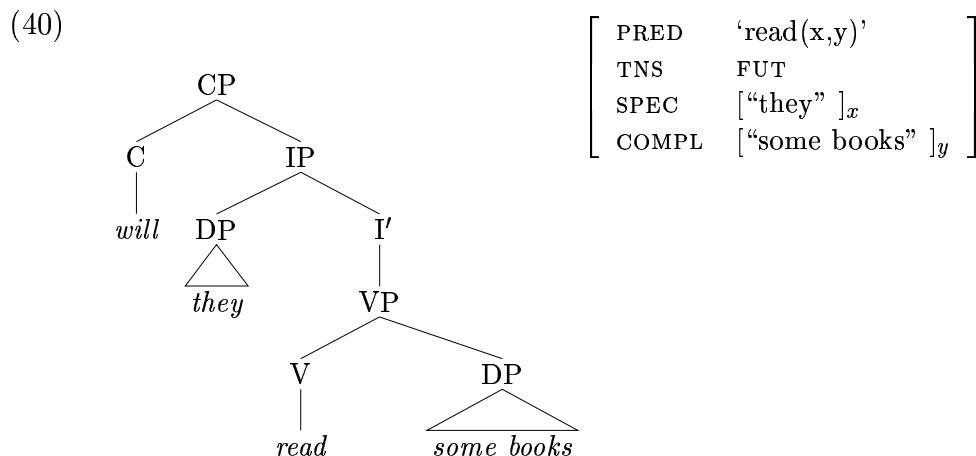

(41) Tableau 2: Matrix declaratives:

	CANDIDATES:	OP	OB-HD	AGR	FULL	STAY
⇒	i [IP DP will [VP read books]]					
	ii [CP e [IP DP will [VP read books]]]		*			
	iii [CP will [IP DP e [VP read books]]]					*
	iv [CP will [S DP [VP read books]]]			*		

Turning now to yes/no questions, while (38b) is ungrammatical for the declarative input in (39), it is grammatical for an appropriate interrogative input. What should this input be? Grimshaw’s solution is to postulate a null operator in SPEC of CP (hedging in footnote 4 (380), however). This empty operator requires an FP which needs a head to avoid an OB-HD violation, thus bringing about auxiliary inversion. We could adopt this approach, but there is some evidence that it is incorrect (Toivonen 1996). Moreover, such a null operator is a language-particular lexical solution: other languages may make use of overt yes/no question markers (e.g. Russian *li*, Chicheŵa *kodi*) which can be classed with complementizers (a complementizer clitic in the case of Russian (King 1995)), and the same may be true crosslinguistically (cf. Grimshaw’s n. 4). Thus, a better solution may be to let GEN universally treat C as the category carrying information about formally marked ‘sentence types’ such as interrogative (Sadock and Zwicky 1985). For purposes of these exploratory notes, I will assume that the verbal category C (that is, C filled by a verb) specifies a value for the attribute DF. Thus, *will*, like most English modals, belongs to the category F, comprising I and C; when generated in C by GEN, it carries an additional attribute (\uparrow DF OP) = Q, yielding the feature structure [DF [OP Q]].²⁰ The latter can be viewed as a property of all verbal members of C. Given this analysis, only inverted forms will be faithful to the input for a yes/no question.

I will pass over a demonstration of how Grimshaw’s results with multiple *wh*-questions are derived. As with the preceding examples, the present account is equivalent to hers because of the essential equivalence of both structural analyses and constraints.

²⁰This is overly narrow, because inversions are used for other marked sentence types than questions. Presumably a fuller range of sentential operators is available.

The distribution of *do*. The present framework provides an interesting perspective on Grimshaw’s explanation for the distribution of the English auxiliary verb *do*. The generalization Grimshaw wishes to capture—the rather delphic pronouncement “*do* is possible only where it is necessary” (381)—means, in effect, that *do* is used only where it fills specific functions. The functions, according to Grimshaw, are to satisfy her OB-HD and CASE constraints (meaning that it fills the head position required either by having a *wh*-phrase in SPEC of CP or by having an IP above NegP required for the ‘case’ or agreement features that license the subject). To capture the fact that *do* is ungrammatical elsewhere, there must be a constraint that penalizes its presence, but is outranked by these constraints. Because the auxiliary *do* is commonly analyzed as a semantically empty carrier of tense inflections, one could simply propose that all semantically empty elements incur a mark, but Grimshaw relies elsewhere on the unmarked use of such elements (for example, in allowing the free variation of IP and CP propositional complements (her tableau 24)). Hence, she proposes a constraint of “Full Interpretation” (FULL in our tableaux), which is intended to make the purely grammatical use of meaningful elements marked (in the OT sense).

The idea is that the auxiliary verb *do* is a use of the main verb *do* which does not ‘parse’ the lexical semantics (‘lcs’) of the main verb. It is unclear from her account, however, exactly how this material is ‘unparsed’: is it present in the input? In the OT of Prince and Smolensky 1993 PARSE constraints enforce faithfulness to the input. Yet an input containing the main verb *do* (with its lcs waiting to be unparsed) together with the main verb it accompanies would be semantically incoherent, having two unintegrated semantic structures for a single predication. On the other hand, if *do* is introduced into the output by GEN as a kind of syntactic analogue to epenthesis (which seems to be what Grimshaw has in mind), how can its meaning be ‘unparsed’? The role of lcs within derivational syntax has been to ‘project’ an argument structure and thence an initial X’ structure in the transformational derivation (e.g. Grimshaw 1990, Rappaport Hovav and Levin 1995). It is quite obscure how an unparsed lcs could project anything at all. Grimshaw’s proposal seems to assume quite inexplicitly a very different view of how these structures are related: that in addition to the X’ structures there is a parallel level of representation containing the lcs, which is being ‘parsed’ in GEN. However, the serial derivational framework lacks an explicit correspondence theory of such parallel structures, and the same is true of Grimshaw’s representational version. Since Grimshaw never states where ‘lcs’ (the lexical semantics) appears in this model, its role,

like that of LF, remains inexplicit and is conveyed primarily by metaphorical appeals to phonology.

This unclarity can be removed by modelling the situation within an explicit parallel correspondence architecture of syntax. In the present framework, Grimshaw’s ‘lcs’ can be modelled by the lexical PRED, her ‘parsed’ relation by the correspondence mapping between c-structure and f-structure, and her ‘Full Interpretation’ (FULL(-INT)) constraint by the FAITHFULNESS relation between the output f-structure and the input f-structure. This I will now demonstrate.

It is the lexical semantics which projects the a(rgument)-structure, and it is the a-structure which is the value of the PRED attribute. So in our terms the auxiliary verb *do* lacks a lexical PRED attribute. Grimshaw wishes to have the result that every time we use the auxiliary verb *do*, it creates a FULL(-INT) violation. In our terms, this means that it has an attribute (the ‘unparsed’ PRED) that does not correspond to the input. There is a simple way to model this idea formally in GEN in the present framework.

In this framework, words are modelled as sets of morpholexical constraints on parallel structures, as I remarked at the outset. Hence the correspondence between c-structure and f-structure at the word level is defined by the same formal system as the correspondence at the syntactic phrasal level. The parallel categorial and feature structures of a word like *did* can be represented as follows:

$$(42) \quad \begin{array}{c} V_z \\ | \\ did \end{array} \left[\begin{array}{cc} \text{TNS} & \text{PAST} \\ \text{PRED} & \text{'do(x,...)'} \end{array} \right]_z$$

The feature structure in (42) is the unification of the two simple feature structures in (43):

$$(43) \quad \begin{array}{c} V_z \\ | \\ did \end{array} \left[\begin{array}{cc} \text{TNS} & \text{PAST} \end{array} \right]_z \left[\begin{array}{cc} \text{PRED} & \text{'do(x,...)'} \end{array} \right]_z$$

Every f-structure is the unification of a set of such simple feature structures. What GEN does is integrate the partial c- and f-structures of words with those of phrasal configurations by fitting together the various pieces of the categorial structure and unifying the corresponding partial feature structures. All we need to do to model a failure to ‘parse the lcs’ is to let GEN set aside one of

the simple lexical feature structures—specifically, the PRED feature. The result will be a *disconnected* f-structure, having some unused lexical attributes which were set aside by GEN:

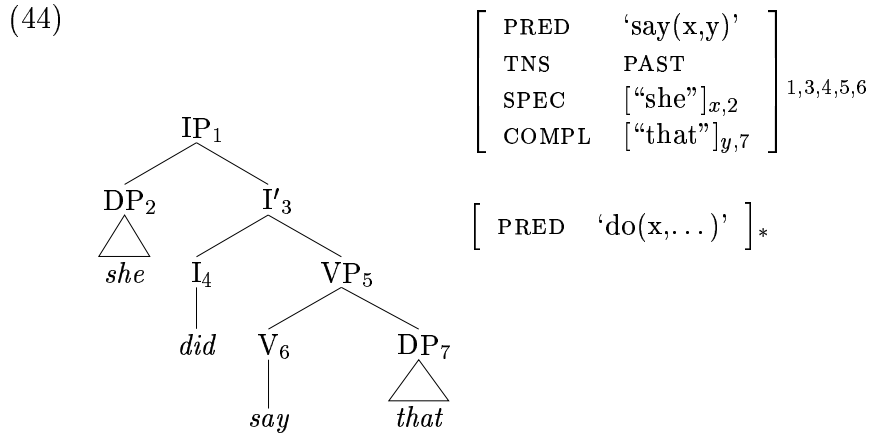

The unused little f-structure indexed by * in (44) was set aside by GEN; it does not correspond to anything in the input (45):

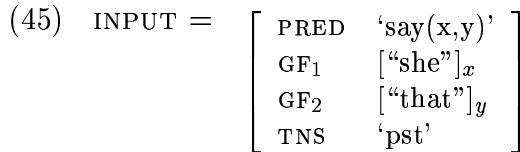

This lack of correspondence is a faithfulness violation, specifically a **FILL-PRED** violation.²¹ Hence the supporting *do* will incur a mark which penalizes its presence except where overriding constraints such as **OB-HD** or the need for

²¹In terms of the formal solution algorithm of LFG (Kaplan and Bresnan 1995 [1982], Bresnan forthcoming), the correspondence between c-structure and f-structure at both the word and phrase level is defined using functional schemata that specify the functional attributes and relations of mother (‘↑’) and daughter (‘↓’) nodes. (For any node N annotated with a f-structure specification schema containing ‘↑’ or ‘↓’, ‘↑’ designates the f-structure of the mother of N and ‘↓’ the f-structure of the N.) The algorithm for defining the correspondence between parallel c- and f-structures involves instantiating these functional schemata with indices referring to the nodes of specific structures. Formally, we can say that an unparsed lexical feature is *uninstantiatable*. Specifically, let us represent an ‘unparsed’ lexical feature as one which instantiates ‘↑’ with an arbitrary index unused in the correspondence mapping between c-structure and f-structure (the ‘parse’); this index is ‘*’ in the following illustration:

affirmative emphasis (not discussed by Grimshaw 1997) apply. This accounts for our next example set (= Grimshaw's (6), 383):²²

- (46) a. She said that.
 b. *She did say that. (unstressed *did*)

(47) Tableau 3: Matrix declaratives with and without *do*:

	CANDIDATES:	OP	OB-HD	AGR	FULL	STAY
⇒	i [S DP [VP V that]]					
	ii [IP DP do [VP V that]]				*!	
	iii [IP e [S DP V that]]		*!			

The distribution of *do* with *wh* questions also follows straightforwardly from this analysis. Consider (48) (= Grimshaw's (7), 383), its input (49), and the outcome (50):

- (48) a. What did she say?
 b. *What she said?
 c. *What she did say?

(49) INPUT =
$$\begin{bmatrix} \text{TNS} & \text{PAST} \\ \text{PRED} & \text{'say}(x,y) \\ \text{GF}_1 & \text{["she"]}_x \\ \text{GF}_2 & \text{["what"]}_y \\ \text{DF} & \end{bmatrix}$$

main verb *did*: (↑ PRED) = 'do(x,...)'
 (↑ TNS) = 'pst' ⇒
 aux verb *did*: (* PRED) = 'do(x,...)'
 (↑ TNS) = 'pst'

Then following exactly the same (LFG) correspondence algorithm used elsewhere in GEN, the disconnected f-structure shown in (44) results.

²²Note that the S in candidates (i) and (iii) does not violate AGR, in contrast to candidate (v) of Tableau 1 and (iv) of Tableau 2. That is because the extended head of the subject in (i) and (iii), which is the main verb in (46), is finite, and can satisfy AGR.

(50) Tableau 4: Matrix interrogatives with and without *do*:

	CANDIDATES:	OP	OB-HD	AGR	FULL	STAY
⇒	i [CP wh do [IP DP e [VP V [e]]]]				*	**
	ii [CP wh e [IP DP e [VP V [e]]]]		*!			*
	iii [CP wh e [S DP [VP V [e]]]]		*!			*
	iv [CP wh e [IP DP do [VP V [e]]]]		*!			*

The examples so far are parallel to Grimshaw's both in structural descriptions for the optimal outputs and in the patterns of violation of the constraints. The same is true for the next set of examples (= Grimshaw's (8), 384). (51a) wins over (b,c) because the latter are penalized for unfaithfulness, having empty *do*:

- (51) a. What will she say?
 b. *What will she do say?
 c. *What does she will say?

The penalties for *do* accumulate, just as in Grimshaw's analysis, explaining (52) (= Grimshaw's (9), 384):

- (52) a. What did she say?
 b. *What did she do say?
 c. *What did she do do say?

We see, then, that the distribution of the auxiliary *do* can indeed be explained as a syntactic analogue of phonological epenthesis, which appears to be the intended substance of Grimshaw's proposal. *Do* arises as outlined above; it is hypothesized to be the element in the infinite candidate set that allows the most harmonic balancing of constraints, including both OB-HD and FULL. The unparsing of its semantically minimal PRED feature is a smaller violation of faithfulness than that incurred by unparsing the semantically richer PREDs

of *shout*, *obfuscate*, or any other verb in the English lexicon.²³ By replacing Grimshaw's derivational GEN with an explicit parallel correspondence ('linking') theory of syntax, we can quite naturally model 'unparsing' as imperfect correspondence. No new rules or structures need be added to the framework; the possibility of syntactic epenthesis is (and always has been) intrinsic in the formal correspondence architecture of this syntactic framework.

Main Verbs and *do*. The Optimal Syntax framework can obtain main verb inversion by reranking, just as Grimshaw does. To explain why only auxiliary verbs invert in English, as shown in (53) (= Grimshaw's (10), 385)—

- (53) a. *What said she?
b. What did she say?

—Grimshaw adds a new constraint: NO-LEX-MVT, which marks movement of a lexical head. She does not define what counts as a 'lexical head' in language-independent terms, which is crucial for determining the typological validity of this constraint. It is clear that having semantic content is not sufficient to be a lexical head, because the English modals have this property, but are generated in I and not V. They are always 'functional heads' F in the sense of extended X' theory and its functional projections (FP), and never lexical heads.

For purposes of this exploratory demonstration, let us assume that a lexical head has a (parsed) lexical PRED attribute, and that modal auxiliaries carry semantic features of other types. (For example, we have tacitly represented the English modal verb *will* as carrying TNS = FUT.) Then we can recast Grimshaw's NO-LEX-MVT constraint in nonderivational terms as *a constraint on categorization*:

- (54) *LEX-F: No lexical heads in functional categories.

²³Presumably other semantically minimal verbs, such as *be* or *have*, have other features that diminish faithfulness. There is some evidence (brought to my attention by Dick Hudson, p.c., March 7, 1997) that other features may be involved even with *do*: some nonstandard dialects of English use different tense forms for main and auxiliary verb *do* (Cheshire 1978). There are also dialects of German that allow *tun* 'do' in verb second position as an auxiliary to the main verb (Susanne Riehemann, p.c.). Further empirical investigation is needed.

By ranking this constraint just where Grimshaw ranks her NO-LEX-MVT constraint, we can derive all of her results. For example, (53a,b) compare as follows:²⁴

(55) Tableau 5: Inversion of a main verb vs. presence of *do*:

	CANDIDATES:	OP	*LEX-F	OB-HD	AGR	FULL	STAY
	i [CP wh V [S DP [VP e [e]]]]		*!				**
⇒	ii [CP wh do [IP DP e [VPV [e]]]]					*	**
	iii [CP wh do [S DP [VP V [e]]]]				*!		*

Under the re-ranking of *LEX-F, main verb inversion would result, exactly as in Grimshaw (386):

(56) Tableau 6: Effect of re-ranking on verb/*do* inversion:

	CANDIDATES:	OP	OB-HD	AGR	FULL	*LEX-F	STAY
⇒	i [CP wh V [S DP [VP e [e]]]]					*	**
	ii [CP wh do [IP DP e [VPV [e]]]]				*!		**
	iii [CP wh do [S DP [VP V [e]]]]			*!			*

We can now also capture Grimshaw’s derivation of lexical gaps (such as the lack of an empty auxiliary *do*) from constraint ranking, since our account is (in substance) isomorphic with hers, for the range of data she considers.

***Do* and *wh*-subjects.** Grimshaw explains the interaction of *do* and *wh*-subjects shown in (57) (= Grimshaw’s (13), 388) by letting the VP-internal subject count as a “specifier position” for OP-SPEC:

- (57) a. Who saw it?
 b. *Who did see it? [unstressed *did*]

Since this SPEC of VP position is already a prominent SPEC position, according to Grimshaw, no CP and no head movement are needed, and we are more harmonic without them (because of FULL, which penalizes *do*).

²⁴In both (i) and (iii) of Tableau 5, the verb V is the extended head of the VP sister to the subject. The fact that this V is finite in (i) but not in (iii) accounts for the difference in AGR violations.

The same result follows from our reformulation of OP-SPEC as requiring that an operator must be the value of a DF in the f-structure. By definition the subject function is one of the DF functions (Bresnan forthcoming).²⁵ Grimshaw's results now follow:

$$(58) \text{ INPUT} = \left[\begin{array}{l} \text{DF} \swarrow \\ \text{GF}_1 \longrightarrow [\text{"who"}]_x \\ \text{PRED} \quad \text{'say(x,y)'} \\ \text{GF}_2 \quad \quad [\text{"it"}]_y \\ \text{TNS} \quad \quad \text{'pst'} \end{array} \right]$$

(59) Tableau 7: The position of subject *wh*-phrases:

CANDIDATES:		OP	OB-HD	AGR	FULL	STAY
⇒	i [S wh [VP V it]]					
	ii [CP wh e [S [e] [VP V it]]]	*!				*
	iii [CP wh did [S [e] [VP V it]]]			*!	*	*
	iv [IP wh e [VP V it]]		*!	*		

Negation and *do*. Grimshaw's analysis of negation assumes that Neg heads a functional projection in the phrase structure, and that a conspiracy of constraints and conditions causes it to appear below IP (or TP). By Grimshaw's CASE constraint, the subject must be licensed by appropriate agreement features, which Neg lacks. By her SUBJ constraint, the subject must appear in the SPEC of the highest 'I-related' head, of which Neg (but not C) is one. It follows Neg must be c-commanded by the agreeing verb and cannot c-command the subject. Thus Grimshaw's theory hypothesizes negation structures like (60). (This example also shows the trace of the subject raised successively from its VP-internal position, through SPEC of NegP, to SPEC of IP.)

²⁵The SUBJ is universally optionally identified as the default TOP of the clause. See the discussion and references in Andrews 1985.

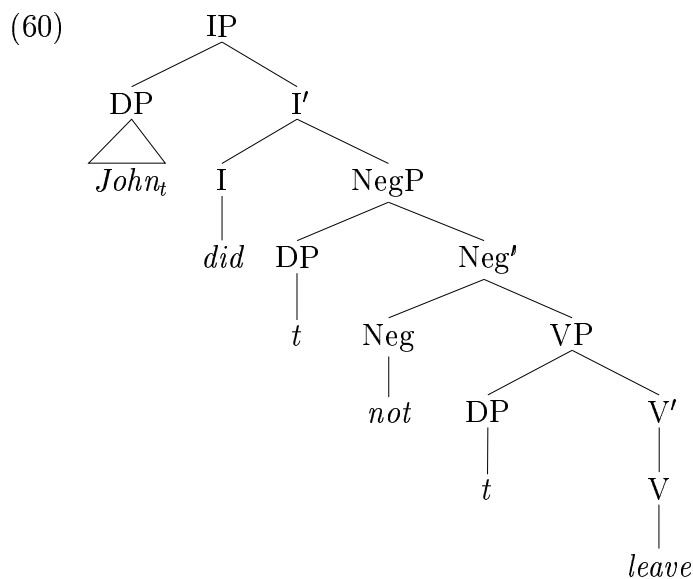

However, this proposal does not capture the fact that standard sentence negation *not* seems to form a constituent with the finite verbal auxiliary. Constituency is suggested by the possibility of constituent coordinators *both ... and ...* and *either ... or ...*—

- (61) a. John either did or did not leave.
 b. Mary both may not and must not come.
 c. You either were not or are not included.

—and by the fact that this constituent has been lexicalized in the form of negative auxiliary verbs: *didn't*, *aren't*, *isn't*, *weren't*, etc. As shown by Zwicky and Pullum 1983, contracted *n't* is an affix, not a clitic. These considerations suggest the alternative syntactic structure shown in (62):

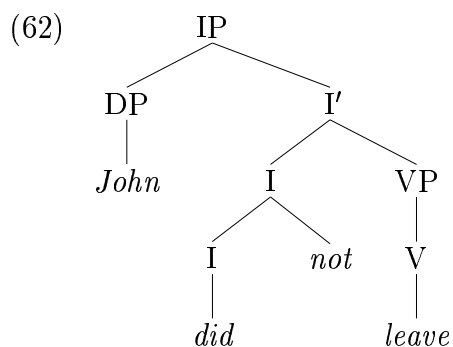

Here standard sentence negation *not* is adjoined to I. See Bresnan 1997b for further evidence and discussion.

This alternative immediately accounts for the distributional facts about sentential negation *not* in finite clauses cited by Grimshaw 1997 (her examples (15)–(18), 390–1).

- (63) a. *John not left.
b. *Not John left.
c. *John left not.
d. John did not leave.

- (64) a. Who did not leave?
b. *Who not left?

Grimshaw considers an analysis similar to the above, but rejects it because *not* stands alone in subjunctive clauses in English, as shown in (65) (= Grimshaw's (19), 392):

- (65) a. I insist that John not leave.
b. *I insist that not John left.
c. *I insist that John do not leave.
d. *I insist that John leave not.

Kim and Sag (1996: 9) also point to examples where an adverb separates the finite auxiliary from *not* as evidence against adjoining *not* to the finite auxiliary:

- (66) a. They will obviously not have time to change.
b. You are usually not thinking about the problem.
c. They are obviously not good citizens.

They propose instead that *not* selects a nonfinite VP in English (similar ideas are found in the analyses of Baker 1991, Ernst 1992, Warner 1993: 86, and Williams 1994). This would offer an alternative account of the examples in (63)–(64). However, as Grimshaw (1997: 392) observes, the lexical specification for (non)finiteness seems arbitrary. Further, such an approach offers no explanation for examples like (67), which though they may be accepted as expressions of sentence negation in a formal style, are fully obsolete in the English of many speakers (except perhaps in contrastive uses):²⁶

- (67) a. %Did he not leave?
 b. %Is she not smart?

How can these problems be resolved? The possibilities for standard sentence negation that we see in English are instances of a much broader typological generalization (Payne 1985): across languages negation is realized as a *verbal category*—by means of negative lexical verbs, negative auxiliaries, negative verbal inflections, and negative particles adjoined to verbs or verb phrases. For example negation may be expressed by full negative lexical verbs which take complements containing the lexical verb of the affirmative proposition being negated (see Unseth 1994 for a detailed example). Among languages which have invariant negative particles for standard negation—like English *not* and Russian *ne*—the negative particle is most often adjacent to the verb, exactly as expressed by our adjunction analysis (62).²⁷ Thus it is reasonable to assume that the structure in (62) is one typological instantiation of a universal (and violable) constraint on categorization classifying standard sentence negation as a verbal category. But this candidate structure competes with others, including the expression of negation by means of a particle adjoined to a verb phrase rather than to a verb. Harmonically ranking the finite-auxiliary adjunction analysis above the VP adjunction analysis would explain why adjunction of *not* to VP in English emerges only in restricted circumstances when the finite auxiliary is unavailable, such in subjunctive complements (as in (65)), or when faithfulness to adverbial scope relations overrides the preference for adjunction to I (as in (66)).

²⁶An example of this type is accepted without comment by Warner (1993: 86), so there may be variation in American and British usage.

²⁷According to King 1995, Russian *ne* ‘not’ also adjoins to I, and her work on cliticization and prosodic inversion in Slavic (King 1996) shows that this analysis can be uniformly maintained across a variety of Slavic languages that otherwise differ in word order.

Modern English adjoins *not* to a verbal category, but not to any verbal category. C and V are excluded, as shown by (68b and c), respectively:

- (68) a. He did not leave.
b. *Did not he leave?
c. *He left not.

In other words, *not* in modern English is ‘I-related’, as Grimshaw 1997 stipulates in her principle for interpreting her SUBJ constraint. Our alternative hypothesis is that *not* adjoins to I, not C. This can be viewed as a violable categorization constraint, one of a family of (rerankable) constraints instantiating the universal verbal categorization of negation. (See Bresnan 1997b.) Note further that since the syntactic constituents of I never get moved to C in Optimal Syntax, *not* is never dragged with them, and since virtually all auxiliary verbs in English are categorized as F, occurring in both I and C, the lexically inflected negative auxiliaries are expected to belong to this class as well. Thus we easily explain the contrast between (69a,b):²⁸

- (69) a. *Did not he leave?
b. Didn’t he leave?

In sum, we have adopted the categorization constraint in (70) as one instance of a family of constraints requiring negation to belong to a verbal category; in English it dominates constraints allowing the negative particle to adjoin to VP:

- (70) NEG-TO-I: A negative particle adjoins to I.

In addition, we have assumed that finite auxiliaries in English are categorized as verbal functional heads; we need not formulate a separate constraint to this effect, however, since it would follow from interpreting *LEX-F (54) bidirectionally.

To see in detail how the present analysis works, consider the following pair of examples:

²⁸Warner (1993: 86, 250) presents examples like (69a) as grammatical, citing Quirk et al. (1985) who observe that “some speakers accept” it as a “rather formal” construction. He nevertheless finds the uncontracted negation in tags ungrammatical (*—*did not he?*, *—*is not she?*), an exception he attributes to “weight ordering”.

- (71) a. He did not leave.
 b. He didn't leave.

These examples illustrate an important feature of the parallel correspondence theory that I referred to at the outset: that lexical words may correspond to the same feature structures as syntactic phrases. Let us hypothesize the respective representations in (72) and (73) for *did* and *didn't* (ignoring the unparsed PRED attribute for present purposes). The attribute POL represents 'polarity', and is contributed morphologically by the negative affix to the form *didn't*. The category 'F' represents a verbal functional projection (I or C), allowing these auxiliaries to appear in both inverted and uninverted positions. The attribute [DF [OP Q]] is associated with the C instantiation of verbal F by the conditional constraint in (74), as in the discussion of yes/no questions above.

$$(72) \quad \begin{array}{c} F_i \\ | \\ did \end{array} \quad \left[\begin{array}{cc} \text{TNS} & \text{PAST} \end{array} \right]_i$$

$$(73) \quad \begin{array}{c} F_i \\ | \\ didn't \end{array} \quad \left[\begin{array}{cc} \text{TNS} & \text{PAST} \\ \text{POL} & \text{NEG} \end{array} \right]_i$$

$$(74) \quad \begin{array}{c} C_i \\ | \\ \text{verb} \end{array} \Rightarrow \left[\begin{array}{cc} \text{DF} & [\text{OP Q}] \end{array} \right]_i$$

Observe that the lexical negative auxiliary *didn't* has exactly the same feature structure as the partial c-structure we hypothesize for analytic sentence negation:

$$(75) \quad \begin{array}{c} I_i \\ / \quad \backslash \\ I \quad not \\ | \\ did \end{array} \quad \left[\begin{array}{cc} \text{TNS} & \text{PAST} \\ \text{POL} & \text{NEG} \end{array} \right]_i$$

Thus we have both (77) and (78) in the near-optimal portion of the candidate set for the input (76):

$$(76) \text{ INPUT} = \begin{bmatrix} \text{PRED} & \text{'leave(x)'} \\ \text{GF} & [\text{"he"}]_x \\ \text{POL} & \text{NEG} \\ \text{TNS} & \text{PAST} \end{bmatrix}$$

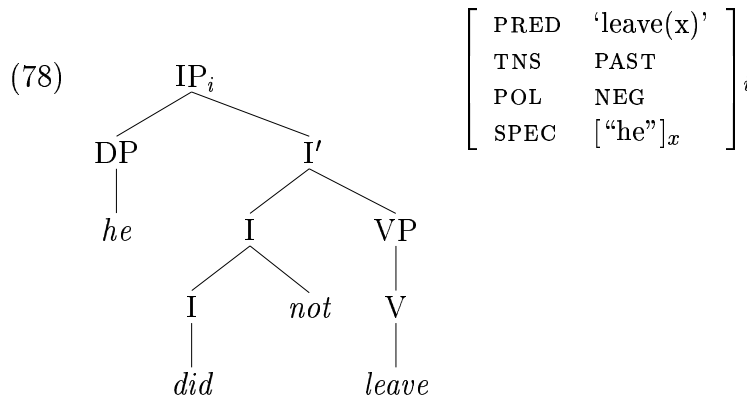
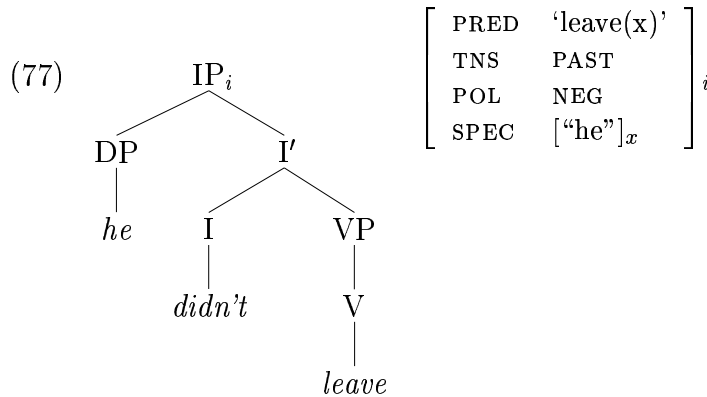

The feature-structure content of these two candidates is identical.²⁹ None of our constraints distinguish these candidates.³⁰ Hence, the candidates will fare

²⁹Some contracted negative modals differ in scope relations from uncontracted ones, and so would not be equivalent candidates. Unlike the present examples, these would be distinguished by faithfulness to different semantic inputs. See Bresnan 1997b.

³⁰The constraint DON'T-PROJECT penalizes unnecessary use of phrase structure (nonterminal and non-preterminal) nodes, favoring lexical over structural expressions. However, it does not penalize (77) because the I immediately dominating *not* is a preterminal node. The constraint marks any c-structure node which does not immediately dominate a lexical element. Both instances of I in our *not* adjunction structures immediately dominate lexical elements.

identically with respect to EVAL, and both will in fact be optimal for the given input. (Possibly there are nonsyntactic factors such as style or speech level that choose between these forms, but they are disregarded in this account of the syntax. They are equally marked by all of the constraints of interest here.)

To see why the yes/no interrogative counterparts (74a,b) of these declarative alternants differ in grammaticality, it is necessary only to examine the following two respective structures for (74a,b):

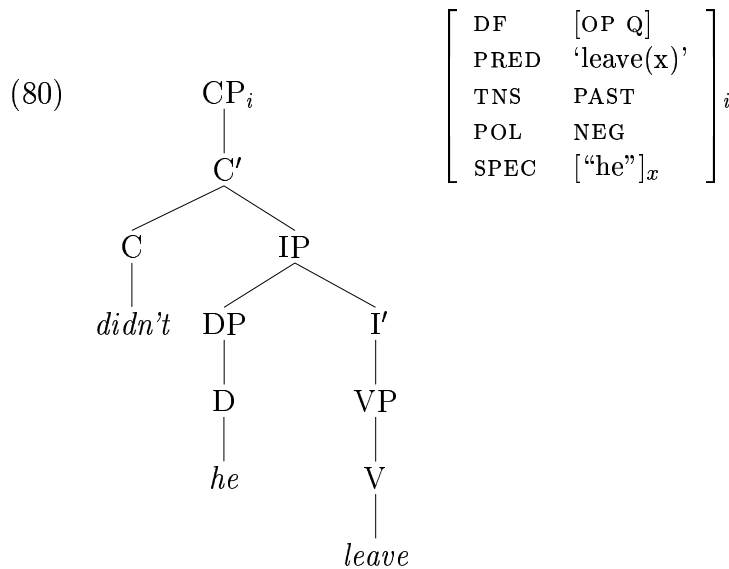
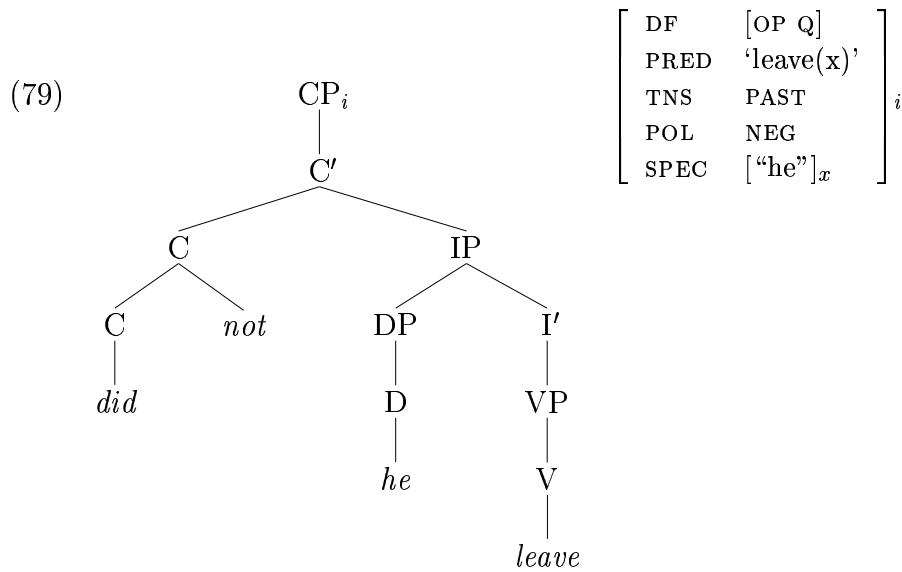

As with the declaratives, the feature structures are identical. The negatively inflected auxiliary *didn't* in (80) and the *did* in (79) both satisfy the bidirectional categorization constraint *LEX-F: they are functional heads in functional categories. In contrast, the analytic negative *did not* in (79) violates the categorization constraint NEG-TO-I (70), because *not* is adjoined to C, not I, and so incurs a fatal mark.

Now with this analysis, we can explain Grimshaw's example sets, the additional data showing constituency of *not* and I, and the alternation contrasts with inflected and analytic negatives, repeated here:

(81) a. He did not leave.

b. He didn't leave.

(82) a. *Did not he leave?

b. Didn't he leave?

3 Evidence for Imperfect Correspondence

We have now seen how Grimshaw's derivationally-framed ideas can be translated into the Optimal Syntax framework without loss of generality and with some empirical and conceptual gains. The interest of this exercise, however, is not only in showing how Grimshaw's theory can be reconstructed in a truly nonderivational framework, but in discovering thereby a solution to an inversion problem that has resisted explanation in other terms.

As we observed above, most finite auxiliaries of English show regularity in occurring in I or C (inverted) position, as captured in (83):

(83) $\text{verb}_{aux,fin} \in F$
 $\text{verb}_{fin} \in V$

This property in turn may be derived from the constraint rankings of *LEX-F, FULL, and OB-HD, and the bidirectionality of *LEX-F, as discussed in just below (70). Despite these regularities there are specific lexical elements in English that appear only in a restricted category. A well-known example is that *aren't* plays the role of the first person singular present negative form of *be* in some varieties of English which lack negative inflection of *am* in the paradigm of *be* (cf. Langendoen 1970, Hudson 1977, Dixon 1982, Gazdar et al. 1982, Kim and Sag 1996):

(84) *aren't* \in C [first person singular]

The asymmetry appears in (85):

- (85) a. Isn't she smart? \sim She isn't smart.
b. Aren't you smart? \sim You aren't smart.
c. Aren't I smart? \sim *I aren't smart.

Various hypotheses have been advanced about the sources of this gap in the inflectional paradigm of *be*. Some dialects of English have first person negative forms *amn't* or *ain't*, but these have been dropped from standard English, possibly as a result of phonological complexity (Dixon 1982 on *amn't*) or social stigmatization (*ain't*); see Bresnan 1997b for further discussion. What is important to observe here is that the analytic form of negation (*not* adjoined to I) only partially fills this gap:

(86) *Am not I smart? \sim I am not smart.

This fact follows from the analysis given in Section 2: *not* is categorized as an adjunct to I and there is no I-to-C movement; hence *not* cannot appear in inverted position.³¹ That leaves just one cell in the paradigm to fill: the inverted (verbal C) position, and this is precisely the role of *aren't*, as shown in (84).

Such cases are an embarrassment to movement theories: in a case like (85c), for example, a 'moved' element fails to have a source position from which movement could have occurred. One might propose, following the style of work in the Minimalist Program, that there is some special feature carried by the particular form *aren't* in the first person singular that requires it to be checked in (and hence moved to) C.³² But what feature could this be? One might respond that this could be whatever feature allows us to lexically categorize it as belonging to the restricted category C in our framework, as in (84) (see Kim and Sag 1996 for an example of this approach using the feature [+INV]). However, in the Optimal Syntax framework we need no such special lexical feature at all, as I will now demonstrate.

³¹In terms of the logic of markedness on OT, this categorization means that in English adjoining *not* to other categories than to I as standard sentence negation generally incurs more marks.

³²—a possibility suggested by Jane Grimshaw, personal communication, March 23, 1996.

The most harmonic solution to an overall set of constraints on the expression of some input may force a lexicalization that is not perfectly faithful to the input, but which is the best match available to the input within the paradigm. The use of *aren't* for the inverted first person singular appears to be such a case. The table in (87) shows that *are* is the least marked form in the present tense paradigm of *be* for expressing both number and person:³³

(87)

	sg	pl
1	am	are
2	are	are
3	is	are

The corresponding negative paradigm is shown in (88); as remarked above, it is defective, lacking a negatively affixed form of *am*:

(88)

	sg	pl
1		aren't
2	aren't	aren't
3	isn't	aren't

Each of these verbal forms has a corresponding feature structure expressing tense, polarity, and the person and number of the subject. For example, the feature structure for *isn't* is illustrated in (89):

(89)

F_i	[TNS	PAST]				
	[POL	NEG]				
<i>isn't</i>	[SPEC	[PERS	3]]	i
			[NUM	SG]		

As discussed in Section 2, the analytic standard sentence negation form has an identical feature structure, but is shown adjoined to I in accordance with the categorization constraint NEG-TO-I:

³³The significance of this fact in the present context was pointed out to me by Jane Grimshaw, personal communication, Feb. 23, 1996.

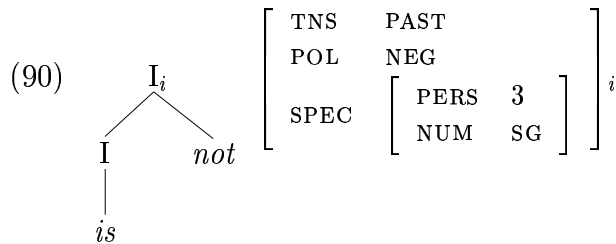

Thus, both the analytic and synthetic forms will be close competitors in the candidate set.

Now to represent the fact that *are* and *aren't* are unmarked members of their paradigms, we can assume that they simply lack feature values for person and number. This is represented by the feature structure in (91), which has valueless attributes PERS and NUM:³⁴

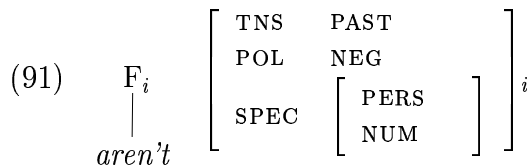

How do we interpret such unmarked features with respect to the input? Let us assume with Grimshaw 1996 that the input is fully specified for all features and that candidate forms may be partially specified. We further assume with Grimshaw that FILL penalizes any form which specifies a feature value that conflicts with the input, while PARSE penalizes any form that does not preserve the feature value of the input. FILL thus exempts partially specified forms from marks if they do not conflict with the input.

To explain in this framework why unmarked forms are preferred over marked forms, we must hypothesize that the FILL constraints dominate the PARSE constraints.³⁵ Finally, we model the accidental lexical gap for the first person

³⁴Formally, the structure in (91) may be taken to represent the presence of the existential constraints (\uparrow PERS) and (\uparrow NUM) associated with this lexical form (Kaplan and Bresnan 1995 [1982]).

³⁵The reverse ranking is also possible, as Grimshaw 1996 shows, though presumably rare. A parallel assumption under the different faithfulness framework of Smolensky 1996a,b is that structural markedness constraints dominate the faithfulness constraints (which include PARSE but not FILL) in the initial state, though reranking can occur. See Bresnan 1997b,c

singular present negative form of *be* by a highly ranked constraint LEX (see Bresnan 1997a,b,c for further discussion and other examples):

- (92) LEX: Structurally nonempty inventory elements must be lexically paired with phonological realizations.

English dialects having the forms *amn't* and *ain't* satisfy this constraint for inputs specifying the first person singular present negative, but Standard English violates it, having no such form.

The details of the analysis follow straightforwardly. We need only assume that the constraint against inverting *not* with the auxiliary (NEG-TO-I (70)) dominates the faithfulness constraints for person and number. Under these assumptions, analytic and synthetic forms will be close competitors. When there are specific forms matching the input, they will be optimal, as shown in tableaux (93) and (94). (Crucial constraint rankings are indicated by vertical bars. We abbreviate the input and candidate feature structures using Grimshaw's 1996 notation: angled brackets enclose a feature structure, features are represented by their values, and valueless or unmarked features by the feature name enclosed in parentheses.)

- (93) Negative third person singular input (declarative)

	INPUT < neg 3 sg >	LEX	NEG-I	FILL	PARSE
⇒	i isn't < neg 3 sg >				
⇒	ii is not < neg 3 sg >				
	iii aren't < neg (P)(N) >				*!*
	iv are not < neg (P)(N) >				*!*
	v am not < neg 1 sg >			*!	*
	vi < neg 1 sg >	*!		*	*

for further development of this alternative faithfulness framework in explaining the problem at hand.

(94) Negative first person singular input (declarative)

	INPUT < neg 1 sg >	LEX	NEG-I	FILL	PARSE
i	isn't < neg 3 sg >			*!	*
ii	is not < neg 3 sg >			*!	*
iii	aren't < neg (P)(N) >				*!*
iv	are not < neg (P)(N) >				*!*
⇒ v	am not < neg 1 sg >				
vi	< neg 1 sg >	*!			

Observe in (94) how the lexical gap for the first person negative is filled by the analytic form *am not*. When the most specified forms conflict with the input, the general forms will be optimal, as we expect:

(95) Negative first person plural input (declarative)

	INPUT < neg 1 pl >	LEX	NEG-I	FILL	PARSE
i	isn't < neg 3 sg >			*!*	**
ii	is not < neg 3 sg >			*!*	**
⇒ iii	aren't < neg (P)(N) >				**
⇒ iv	are not < neg (P)(N) >				**
v	am not < neg 1 sg >			*!	*
vi	< neg 1 sg >	*!		*	*

Now in all these tableaux the analytic (*not*) forms are equally harmonic with the synthetic negative forms available as long as both are in I⁰ (postsubject position). When inverted (in C⁰ position), however, the analytic form will incur a mark by NEG-TO-I, and the synthetic form becomes more harmonic. This is fine in all cases except for the first person singular input, where a synthetic first person singular form is lacking (see (94)). The analytic form still cannot be used in this (inverted) case, which tells us that NEG-TO-I must outrank the PARSE constraints at least. In just this case, the optimal candidate becomes *aren't*:

(96) Negative first person singular input (interrogative):

	INPUT < Q neg 1 sg >	LEX	NEG-I	FILL	PARSE
i	isn't < Q neg 3 sg >			*!	*
ii	is not < Q neg 3 sg >		*!	*	*
⇒ iii	aren't < Q neg (P)(N) >				**
iv	are not < Q neg (P)(N) >		*!		**
v	am not < Q neg 1 sg >		*!		
vi	< Q neg 1 sg >	*!			

What we have demonstrated is that the appearance of *aren't* in the inverted position for the first person singular follows from its unmarked status for person and number in the verbal paradigm for *be*, given the strong constraint against using the analytic forms in inverted position. Its appearance in *only* the inverted position results from the competition by the more harmonic analytic form in the uninverted position.

The negative auxiliary inversion paradigm (85) is an embarrassment for the transformational theory of verb positioning, as noted above and originally observed by Gazdar et al. 1982, because there is no source for the moved form in its underlying position. However, the problem is a deeper one than has been recognized. The correct forms can easily be generated in a transformational framework which allows post-movement feature checking (such as the Minimalist Program). Suppose, for example, that the features shown in (97) are to be checked against derived positions; the feature INV is a special feature which must be checked in C (the inverted position):

$$(97) \text{ aren't: } \begin{bmatrix} \text{P} & 1 \\ \text{N} & \text{SG} \\ \text{NEG} & + \\ \text{INV} & + \end{bmatrix}$$

Now the asymmetry follows straightforwardly. **I aren't smart* is bad because the feature INV cannot be checked in I^0 , although the person and number agreement features can successfully be checked; *Aren't I smart?* is good, because the checking for INV is now satisfied, and the agreement features were checked in I^0 along the derivational path to C^0 . Note, however, that this solution requires overspecification (filling in features for the general form). It thus becomes accidental that it is the *general* form that fills the paradigmatic gap under

this approach, and then only where there is not a more faithful analytic form available. But this is not an accident. Asymmetries in the formal patterns of morphosyntax in other dialects of English and other languages reflect exactly the same factors of paradigmatic competition between alternative morphological and syntactic forms.³⁶

4 Discussion

I have now shown that the effects that Grimshaw attributes to head movement in English (or to its representational simulations) can be captured in the imperfect correspondence theory without any loss of generalization, and that there are further effects—such as the asymmetric distribution of the first person negative auxiliary *be*—that only have an explanation under imperfect correspondence. Let us now step back and reconsider our original motivations for improving on Grimshaw’s framework.

Optimal Syntax and derivationalism. Despite the recent importation of functionalist concepts such as ‘economy’ into transformational theory, it continues to build upon the 50’s and ’60’s technology of serial derivations by transformational rules. While the ’80’s brought representational simulations of derivations with chains and traces, the ’90’s Minimalist Program brings us squarely back to derivationalism (cf. Johnson and Lappin 1996, Jackendoff 1996). The core idea expressed by derivationalism in syntax is that there is an underlying perfect correspondence between roles, functions, and categories, which is distorted by transformational operations (such as movements). The traces that annotate derived X' trees are derivational records of this more perfect correspondence. It is the assumption of perfect correspondence that justifies encoding information about non-tree structures (semantic and functional) into the syntactic tree.

What Optimal Syntax makes evident is that syntactic ‘movements’ are nothing more than imperfect correspondences between different dimension of linguistic substance—roles, functions, and categories—modelled by the correspondence mappings of parallel structures. While it may be highly unmarked for these structures to correspond perfectly, the assumption that perfect correspondence is an inviolable core of UG is conceptually unnecessary and empirically

³⁶See Bresnan 1997a,b,c for further discussion and exemplification.

unwarranted (see Bresnan 1994, 1995, 1996). It also seems counter to the spirit of OT to express violations of universal constraints (such as correspondence) operationally and mechanistically.

Optimal Syntax and lexicalism. As I remarked at the outset, Grimshaw's 1997 syntactic analysis of heads demands nonuniformities in the treatment of morphological inflections. On the basis of differing verb order properties in English and French, she treats the tense and agreement inflections of English as part of its lexical morphology, while she supposes that the tense and agreement inflections of French are syntactically projected as heads of a phrase structure category (IP, TP, AgrP, etc.), to be united with their verbal hosts by movement. From the point of view of either lexicalist or anti-lexicalist morphological theory, this is perhaps the worst of both worlds.

Optimal Syntax is coherently lexicalist. In this framework, the c-structures of English and French are very similar, both languages having I and V as heads of IP and VP and both languages having lexically attached verbal inflections. The two languages differ in verbal categorization, French classing finite verbs as elements of the verbal functional categories F (subsuming I and C), English classing only finite auxiliaries as elements of verbal F:³⁷

- (98) a. English: $\text{verb}_{aux,fin} \in F$
 $\text{verb}_{fin} \in V$
- b. French: $\text{verb}_{fin} \in F$

This difference in turn may be derived from alternative constraint rankings of *LEX-F, FULL, and OB-HD, as discussed in Section 2. The possibility of different verbal categorizations stems from the theory of functional projections F' in Optimal Syntax, which allows imperfect correspondence in the positioning of heads in an extended verbal projection.

Some lexicalist theories of syntax have denied the value of an extended X' theory of functional categories, which they take to be inextricably associated with nonlexicalist derivational syntax (e.g. Pollard and Sag 1994). Following recent work in LFG cited above, Optimal Syntax shows that something of value can be extricated from both lexicalism and extended X' theory.³⁸

³⁷French may not be the most convincing example of a V-to-I language, compared to other languages, but I accept that analysis here for the sake of the argument.

³⁸There are of course problems in giving a clear set of criteria for determining the extensions

However, there is also an important sense in which the lexicalism of Optimal Syntax is qualified. While morphological and syntactic forms of expression are subject to different principles of formation, they correspond to the same types of feature structures under the parallel correspondence theory. It is for this reason that words and phrases may compete as candidate expressions of the same information. The functional equivalence of lexical morphology and syntax is crucial in our explanation of the English auxiliary inversion patterns, and explains many typologically varied ways in which morphology competes with syntax (see Bresnan 1997b, forthcoming, Nordlinger 1997, and the references cited in these).

Substance of constraints. Several of Grimshaw's 1997 constraints (e.g. STAY, NO-LEX-MVT) are formulated in terms of the theory-internal mechanism of movement. In the present framework of Optimal Syntax these have been generalized into constraints that make no reference to specific mechanisms of GEN. The substance of our STAY constraint (24), repeated here—

(99) STAY: Categories dominate their extended heads.

—is about *endocentricity*. The constraint states that an element that functions as the head of XP is dominated by XP. Likewise, our version of NO-LEX-MVT is *LEX-F:

(100) *LEX-F: No lexical heads in functional categories.

The substance of this constraint is about *categorization*. Lexical heads are those having descriptive content, which we have (approximately) modelled by having the PRED attribute. The constraint is that such descriptively contentful elements belong to lexical categories (e.g. V, N, etc.) and not functional categories (e.g. C, I, etc.). Languages which place lexical heads in special functional positions (e.g. Russian or possibly French) do so for overriding reasons.

of the functional categories in a lexicalized X'-theory, but they are no different in principle from the problems of determining the extensions of the lexical categories V, N, A, P, etc., in the face of apparently gradient lexical classes. This problem is given a far more concrete empirical grounding in the present lexicalized version of the theory of functional categories, than it has in derivational frameworks. The use of imperfect correspondence and violable constraints may provide a new solution to problems of gradience in categorization; see Hayes 1997.

Generality of the theory of structures. Although I have only hinted at the possibility (Section 1.3), I think that Optimal Syntax can gracefully generalize to language types which make greater use of morphology than X' configurations to express syntactic relations (see Bresnan 1996, forthcoming, Austin and Bresnan 1996, Choi 1996, Nordlinger 1997, Sadler 1997, Sells 1995). Given the parallel-correspondence theory of structures, the crucial idea is that endocentricity is not an inviolable constraint, built into the very architecture of GEN, but just one among alternative form/content correspondence strategies for natural language. The importance of endocentricity in the optimal outputs of a language will vary with constraint rankings.

5 Conclusion

In Optimality Theory, as we have seen, a grammar consists of ranked constraints which are (i) universal and (ii) violable. Because OT *per se* is a theory of constraint interaction rather than a theory of substantive linguistic constraints, it is compatible with a wide range of substantive theoretical choices. (Some consider this an explanatory weakness of the framework, but it is also the source of its great integrative potential.) In phonology and to a lesser extent morphology, OT has led to a fundamental rethinking of the domain and to the widespread adoption of nonderivational theories. Syntax, in contrast, is still greatly influenced by the derivational frameworks advanced by Chomsky, and much of the initial work applying OT to syntax reflects this way of thinking by simulating derivational analyses. It is instructive to consider the history of architectural design, which shows that earlier designs, for example in bridge-building, persist long after the development of new materials with radically different engineering properties (e.g. steel compared to wood and stone). The purpose of these notes, then, has been simply to stimulate exploration of a wider imaginative space for syntactic analysis, by combining the ideas of imperfect correspondence and violable constraints.

References

- Aissen, Judith. 1998. Markedness and subject choice in Optimality Theory. Revised version of paper presented at the Hopkins Optimality Theory Workshop/Maryland Mayfest 1997, Inner Harbor, Baltimore, May 9–12, 1997.
- Andrews, Avery. 1985. The major functions of the noun phrase. In *Language Typology and Syntactic Description. Vol. 1: Clause Structure*, ed. by Timothy Shopen, pp. 62–154. Cambridge: Cambridge University Press.
- Andrews, Avery D. 1990. Unification and morphological blocking. *Natural Language & Linguistic Theory* 8.507–57.
- Andrews, Avery and Chris Manning. 1993. Information spreading and levels of representation in LFG. *Report No. CSLI-93-176*. Stanford, CA: Center for the Study of Language and Information.
- Anttila, Arto. 1997. *Variation in Finnish Phonology and Morphology*. Stanford: Stanford University Department of Linguistics Ph.D. dissertation.
- Anttila, Arto. In press. Deriving variation from grammar. In *Variation, Change and Phonological Theory*, ed. by F. Hinskens, R. van Hout, and L. Wetzels. Amsterdam: Benjamins.
- Austin, Peter and Joan Bresnan. 1996. Nonconfigurationality in Australian aboriginal languages. *Natural Language & Linguistic Theory* 14.215–68.
- Baker, Lee. 1991. The syntax of English *not*: the limits of Core Grammar. *Linguistic Inquiry* 22.387–429.
- Baltin, Mark and Anthony Kroch (eds) 1989. *Alternative Conceptions of Phrase Structure*. Chicago: Chicago University Press.
- Barbosa, Pilar, Danny Fox, Paul Hagstrom, Martha McGinnis, and David Pesetsky (eds). To appear. *Is the Best Good Enough? Proceedings from the Workshop on Optimality in Syntax, MIT, May 19–21, 1995*. Cambridge, MA: The MIT Press and MIT Working Papers in Linguistics.
- Beckman, Jill N., Laura Walsh Dickey, and Suzanne Urbanczyk (eds). 1995. *Papers in Optimality Theory. University of Massachusetts Occasional Papers 18*. Amherst, MA: GLSA.
- Berman, Judith. 1996. Topicalization vs. left dislocation of sentential arguments in German. In *Proceedings of the First Annual LFG Conference*, August 26–28, 1996, Grenoble, France, ed. by Miriam Butt and Tracy Holloway

- King. On-line, Stanford University: <http://www-csli.stanford.edu/publications/LFG/lfg1.html>.
- Berman, Judith. 1997. Empty categories in LFG. In *Proceedings of the LFG97 Conference*, University of California, San Diego, ed. by Miriam Butt and Tracy Holloway King. On-line, Stanford University: <http://www-csli.stanford.edu/publications/LFG2/lfg2.html>.
- Berman, Judith and Anette Frank. 1996. *Deutsche und französische Syntax im Formalismus der LFG*. Tübingen: May Niemeyer Verlag.
- Börjars, Kersti, Nigel Vincent, and Carol Chapman. 1997. Paradigms, periphrases and pronominal inflection: a feature-based account. *The Yearbook of Morphology*, ed. by Geert Booij and Jaap van Marle, 1–26. Dordrecht: Kluwer Academic Publishers.
- Börjars, Kersti and Carol Chapman. To appear. Agreement and pro-drop in some dialects of English. *Linguistics* 36.1.
- Boersma, Paul. 1997. How we learn variation, optionality, and probability. On-line, Rutgers University: Rutgers Optimality Archive, ROA-221-1097, <http://ruccs.rutgers.edu/roa.html>.
- Brame, M. K. (1978) *Base Generated Syntax*. Seattle: Noit Amrofer.
- Bresnan, Joan (ed) 1982. *The Mental Representation of Grammatical Relations*. Cambridge: The MIT Press.
- Bresnan, Joan. 1982. Control and complementation. *Linguistic Inquiry* 13.343–434.
- Bresnan, Joan. 1994. Locative inversion and the Architecture of Universal Grammar. *Language* 70.72–131.
- Bresnan, Joan. 1995. Category mismatches. In *Theoretical Approaches to African Languages*, ed. by Akin Akinlabi. Lawrenceville, N.J.: Africa World Press, pp. 19–46.
- Bresnan, Joan. 1996. Morphology competes with syntax: explaining typological variation in weak crossover effects. To appear in Barbosa et al. (eds).
- Bresnan, Joan. 1997a. The emergence of the unmarked pronoun: Chicheŵa Pronominals in Optimality Theory. To appear in *BLS-23*.
- Bresnan, Joan. 1997b. Explaining morphosyntactic competition. To appear in *Handbook of Contemporary Syntactic Theory*, ed. by Mark Baltin and Chris Collins. Oxford: Blackwell.

- Bresnan, Joan. 1997c. The emergence of the unmarked pronoun II. Paper presented at the Hopkins Optimality Theory Workshop, Inner Harbor, Baltimore, May 9–12, 1997. On-line, Stanford University: <http://www-csli.stanford.edu/~bresnan/download.html>.
- Bresnan, Joan. Forthcoming. *Lexical-Functional Syntax*. Oxford: Blackwell.
- Bresnan, Joan and Samuel A. Mchombo. 1987. Topic, pronoun, and agreement in Chichewa. *Language* 68.741–82.
- Bresnan, Joan and Samuel A. Mchombo. 1995. The Lexical Integrity Principle: evidence from Bantu. *Natural Language & Linguistic Theory* 13.181–252.
- Bresnan, Joan and Annie Zaenen. 1990. Deep unaccusativity in LFG. In *Grammatical Relations: A Cross-Theoretical Perspective*, ed. by K. Dziwirek, P. Farrell, and E. Mejías-Bikandi, pp. 45–57. Stanford: CSLI Publications/SLA.
- Burton, Strang and Jane Grimshaw. 1992. Coordination and VP-internal subjects. *Linguistic Inquiry* 23.305–13.
- Cheshire, Jenny. Present tense verbs in Reading English. In *Sociolinguistic Patterns in British English*, ed. by Peter Trudgill, 52–68. London: Arnold.
- Choi, Hye-Won. 1996. *Optimizing Structure in Context: Scrambling and Information Structure*. Stanford: Stanford University Ph.D. dissertation.
- Dalrymple, Mary, Ronald M. Kaplan, John T. Maxwell III, and Annie Zaenen (eds). 1995. *Formal Issues in Lexical-Functional Grammar*. Stanford: CSLI Publications.
- Demuth, Katherine and Mark Johnson. 1989. Interaction between discourse functions and agreement in Setswana. *Journal of African Languages and Linguistics* 11.21–35.
- Dixon, R. M. W. 1982. Semantic neutralisation for phonological reasons. In *Where Have All the Adjectives Gone? and other essays in Semantics and Syntax*, 235–8. Berlin: Mouton Publishers.
- Ernst, Thomas. 1992. The phrase structure of English negation. *The Linguistic Review* 9.109–44.
- Gazdar, Gerald, Geoffrey Pullum, and Ivan Sag. 1982. Auxiliaries and related phenomena in a restrictive theory of grammar. *Language* 58.591–638.
- Grimshaw, Jane. 1990. *Argument Structure*. Cambridge, MA: The MIT Press.

- Grimshaw, Jane. 1991. Extended projection. MS. Department of Linguistics and Center for Cognitive Science, Rutgers University.
- Grimshaw, Jane. 1996. The best clitic: constraint conflict in morphosyntax. To appear in *Handbook of Contemporary Syntactic Theory*, ed. by Liliane Haegeman. Dordrecht: Kluwer Academic Publishers.
- Grimshaw, Jane. 1997. Projection, heads, and optimality. *Linguistic Inquiry* 28.373–422.
- Grimshaw, Jane and Vieri Samek-Lodovici. 1995. Optimal subjects and subject universals. To appear in Barbosa et al. (eds).
- Hayes, Bruce. 1997. Gradient well-formedness in Optimality Theory. To appear in *Optimality Theory: Phonology, Syntax, and Acquisition*, ed. by Joost Dekkers, Frank van der Leeuw, and Jeroen van de Weijer. Oxford: Oxford University Press.
- Hudson, Richard. 1977. The power of morphological rules. *Lingua* 42.73-89.
- Jackendoff, Ray. 1996. *The Architecture of the Language Faculty*. Cambridge, MA: The MIT Press.
- Jar, M. n.d. Reconstituted X' constituents in LFG. MS. Palo Alto, CA: Xerox Palo Alto Research Center.
- Johnson, David and Shalom Lappin. 1996. A critique of the Minimalist Program. MS. Yorktown Heights, NY and London: IBM T. J. Watson Research Center and School of Oriental and African Studies, University of London.
- Johnson, Mark. 1988. *Attribute-Value Logic and the Theory of Grammar*. Stanford, CSLI Publications.
- Kaplan, Ronald M. 1995. The formal architecture of Lexical-Functional Grammar. In Dalrymple et al. (eds), pp. 7–27.
- Kaplan, Ronald M. and Joan Bresnan. 1995 [1982]. Lexical-Functional Grammar: a formal system for grammatical representation. In Dalrymple et al. (eds), pp. 29–130. [reprinted from Bresnan (ed) 1982, pp. 173–281.]
- Kaplan, Ronald M. and Annie Zaenen. 1989. Long-distance dependencies, constituent structure, and functional uncertainty. In Baltin and Kroch (eds), pp. 17–42. [reprinted in Dalrymple et al., pp. 137–65]
- Kim, Jong-Bok, and Ivan A. Sag. 1996. French and English negation: a lexicalist alternative to head movement. On-line, Stanford University: <http://hpsg.stanford.edu/hpsg/sag.html>.

- King, Tracy. 1995. *Configuring Topic and Focus in Russian*. Stanford: CSLI Publications.
- King, Tracy. 1996. Slavic clitics, long head movement, and prosodic inversion. *Journal of Slavic Linguistics* 4: 274–311.
- Kroeger, Paul. 1993. *Phrase Structure and Grammatical Relations in Tagalog*. Stanford: CSLI Publications.
- Langendoen, D. Terence. 1970. *Essentials of English Grammar*. NY: Holt, Rinehart, and Winston.
- Legendre, Géraldine, Paul Smolensky, and Colin Wilson. 1996. When is less more? faithfulness and minimal links in *wh*-chains. To appear in Barbosa et al. (eds).
- Legendre, Géraldine, William Raymond, and Paul Smolensky. 1993. An Optimality-Theoretic typology of case and grammatical voice systems. *BLS* 19.464–78.
- Legendre, Géraldine, Colin Wilson, Paul Smolensky, Kristin Homer, and William Raymond. 1995. Optimality and *wh* extraction. In Beckman et al. (eds), pp. 607–36.
- McCarthy, John J. and Alan S. Prince. 1993. Generalized alignment. *Yearbook of Morphology 1993* ed. by Geert Booij and Jaap van Marle, 79–153. Dordrecht: Kluwer.
- McCarthy, John J. and Alan S. Prince. 1995. Faithfulness and reduplicative identity. In Beckman et al. (eds), pp. 249–384.
- Meier, Judith. 1992. *Eine Grammatik des Deutschen im Formalismus der Lexical Functional Grammar (LFG) unter Berücksichtigung funktionaler Kategorien*. Stuttgart: Institut für Maschinelle Sprachverarbeitung, University of Stuttgart.
- Mohanan, Tara. 1995. Lexicality and wordhood: noun incorporation in Hindi. *Natural Language & Linguistic Theory* 13.75–134.
- Netter, Klaus. 1988. Syntactic aspects of LFG-based dialogue parsing. ESPRIT ACORD project 393, Deliverable Task 2.7(a). Stuttgart: Institut für Maschinelle Sprachverarbeitung, University of Stuttgart.
- Netter, Klaus and Ursula Kärcher. 1986. Documentation of the German grammar. ESPRIT ACORD project 393, Deliverable Task 1.4. Stuttgart: Institut für Maschinelle Sprachverarbeitung, University of Stuttgart.

- Niño, Maria-Eugenia. 1995. The multiple expression of inflectional information and grammatical architecture. Paris Colloque de Syntaxe and Sémantique, Oct. 13, 1995.
- Nordlinger, Rachel. 1997. *Constructive Case: Dependent-Marking Nonconfigurationality in Australia*. Stanford: Stanford University doctoral dissertation.
- Nordlinger, Rachel. In press. *A Grammar of Wambaya*. Canberra: Pacific Linguistics.
- Nordlinger, Rachel and Joan Bresnan. 1996. Nonconfigurational tense in Wambaya. In *Proceedings of the First Annual LFG Conference*, August 26–28, 1996, Grenoble, France, ed. by Miriam Butt and Tracy Holloway King. On-line, Stanford University: <http://www-csli.stanford.edu/publications/LFG/lfg1.html>.
- Oehrle, Richard. 1981. Lexical justification. In *The Scope of Lexical Rules*, ed. by M. Moortgat, H. v.c. Hulst, and T. Hoekstra, 201–228. Dordrecht: Foris.
- Payne, John R. 1985. Negation. In *Language Typology and Syntactic Description. Vol. I: Clause Structure*, ed. by Timothy Shopen, pp. 197–242. Cambridge: Cambridge University Press.
- Pollard, Carl and Ivan Sag. 1994. *Head-Driven Phrase Structure Grammar*. Stanford and Chicago: CSLI Publications and University of Chicago Press.
- Prince, Alan and Paul Smolensky. 1993. *Optimality Theory: constraint interaction in generative grammar*. RuCCS Technical Report #2. Piscataway, NJ: Rutgers University Center for Cognitive Science.
- Rappaport Hovav, Malka and Beth Levin. 1995. The elasticity of verb meaning. In *IATL 2: Proceedings of the Tenth Annual Conference of the Israel Association for Theoretical Linguistics and the Workshop on the Syntax-Semantics Interface, 1995*.
- Sadock, Jerrold. 1991. *Autolexical Syntax*. Chicago: University of Chicago Press.
- Sadock, Jerrold and Arnold Zwicky. 1985. Speech-act distinctions in syntax. In *Language Typology and Syntactic Description. Vol. I: Clause Structure*, ed. by Timothy Shopen, pp. 155–196. Cambridge: Cambridge University Press.

- Sadler, Louisa. 1997. Clitics and the structure-function mapping. In *Proceedings of the LFG97 Conference*, University of California, San Diego, ed. by Miriam Butt and Tracy Holloway King. On-line, Stanford University: <http://www-csli.stanford.edu/publications/LFG2/lfg2.html>. Longer version on-line, University of Essex: <http://clwww.essex.ac.uk/~louisa/>.
- Sells, Peter. 1995. Korean and Japanese morphology from a lexical perspective. *Linguistic Inquiry* 26.277–325.
- Sells, Peter. 1997. The typology of grammatical voice systems revisited. Paper presented at the Hopkins Optimality Theory Workshop, Inner Harbor, Baltimore, May 9–12, 1997.
- Sells, Peter. 1998. Scandinavian clause structure and object shift. On-line, Stanford University: <http://www-csli.stanford.edu/sells/scand.ps.gz>.
- Shieber, Stuart and Yves Schabes. 1990. Synchronous Tree Adjoining Grammars. In *Proceedings of the 13th International Conference on Computational Linguistics (COLING '90)*. Helsinki.
- Shieber, Stuart. 1986. *An Introduction to Unification Based Approaches to Grammar*. Stanford: CSLI Publications.
- Simpson, Jane. 1991. *Warlpiri Morpho-Syntax: A Lexicalist Approach*. Dordrecht: Kluwer Academic Publishers.
- Smolensky, Paul. 1996a. On the comprehension/production dilemma in child language. *Linguistic Inquiry* 27.720–731.
- Smolensky, Paul. 1996b. The initial state and ‘richness of the base’ in Optimality Theory. *Technical Report JHU-CogSci-96-4*, Department of Cognitive Science, Johns Hopkins University.
- Sproat, Richard. 1985. Welsh syntax and VSO structure. *Natural Language & Linguistic Theory* 2.173–116.
- Tesar, Bruce and Paul Smolensky. 1996. The learnability of Optimality Theory: an algorithm and some basic complexity results. *Technical Report*, Cognitive Science Department, Johns Hopkins University, Baltimore, Maryland and Rutgers Center for Cognitive Science, Rutgers University, New Brunswick, New Jersey.
- Toivonen, Ida. 1996. On projection, heads and optimality in AAVE. Stanford Syntax Seminar presentation, March 11, 1996.

- Unseth, Peter. 1994. Verbal negation in Majang. Paper presented at the 25th Annual Conference on African Linguistics, 1994, Rutgers University.
- Van Valin, Robert D. Jr. 1993. A synopsis of Role and Reference Grammar. In *Advances in Role and Reference Grammar*, ed. by Robert D. Van Valin, Jr., pp. 1–164. Amsterdam: John Benjamins.
- Vijay-Shanker, K., and Aravind K. Joshi. 1990. Unification based Tree Adjoining Grammars. In *Unification-Based Grammars*, ed. by J. Wedekin. Cambridge, MA: The MIT Press.
- Warner, Anthony R. 1993. *English Auxiliaries. Structure and History*. Cambridge: Cambridge University Press.
- Williams, Edwin. 1994. *Thematic Structure in Syntax*. Cambridge, MA: The MIT Press.
- Zaenen, Annie and Ronald M. Kaplan. 1995. Formal devices for linguistic generalizations: West Germanic word order in LFG. In Dalrymple et al., pp. 215–39.
- Zwicky, Arnold M. and Geoffrey K. Pullum. 1983. Cliticization vs. inflection: English *n't*. *Language* 59.502–13.