

Where to Go from Here

Announcements

- Assignment 7 is due right now.
 - ***Congratulations! You've completed the last assignment of the quarter!***
- Final exam is this upcoming Monday from 8:30AM - 11:30AM. Locations are divvied up by last (family) name:
 - A - O: Go to ***Cubberley Auditorium***
 - P - Z: Go to ***Cemex Auditorium***
- Exam is closed-book and limited-note. You get one double-sided sheet of 8.5" × 11" notes with you.
- Need a laptop? No worries! Let us know and we can prep one for you.

Taking Stock: Where Are We?

Goals for this Course

- ***Learn how to model and solve complex problems with computers.***
- To that end:
 - Explore common abstractions for representing problems.
 - Harness recursion and understand how to think about problems recursively.
 - Quantitatively analyze different approaches for solving problems.

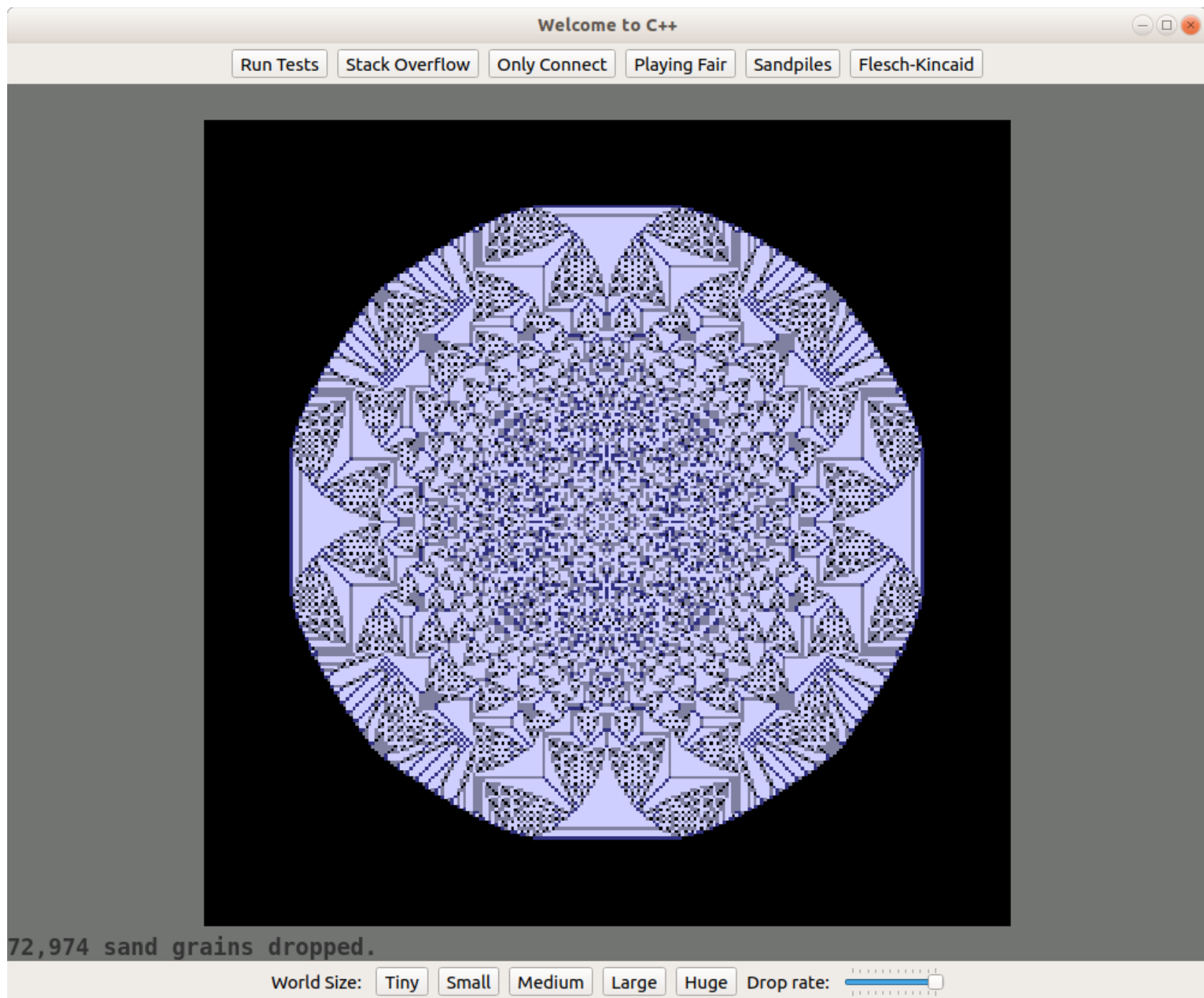

Assignment 1: Strings, Streams, and Recursion

```
Console
File Edit Options Help

Guesses left: 2
Guessed letters: e t o a i n s h r d l u
Word: -u---
Possible words: 21
Guess: m
Sorry, there are no m's.

Guesses left: 1
Guessed letters: e t o a i n s h r d l u m
Word: -u---
Possible words: 13
Guess: p
Sorry, there are no p's.

Game over! You lost.
The hidden word was 'bubby.'

Play again?
```

Assignment 2: Container Types

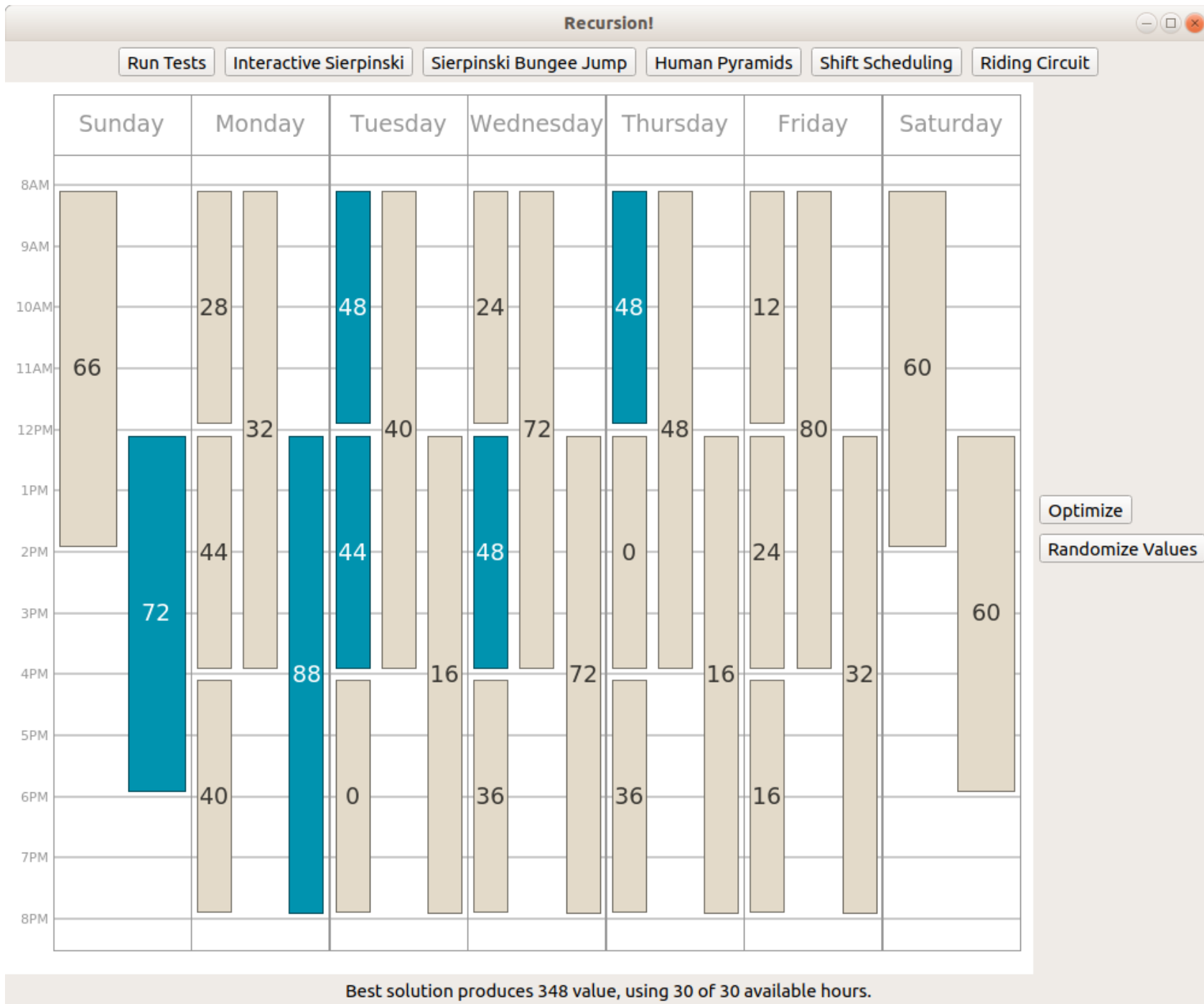

Assignment 3: Memoization, Recursive Optimization

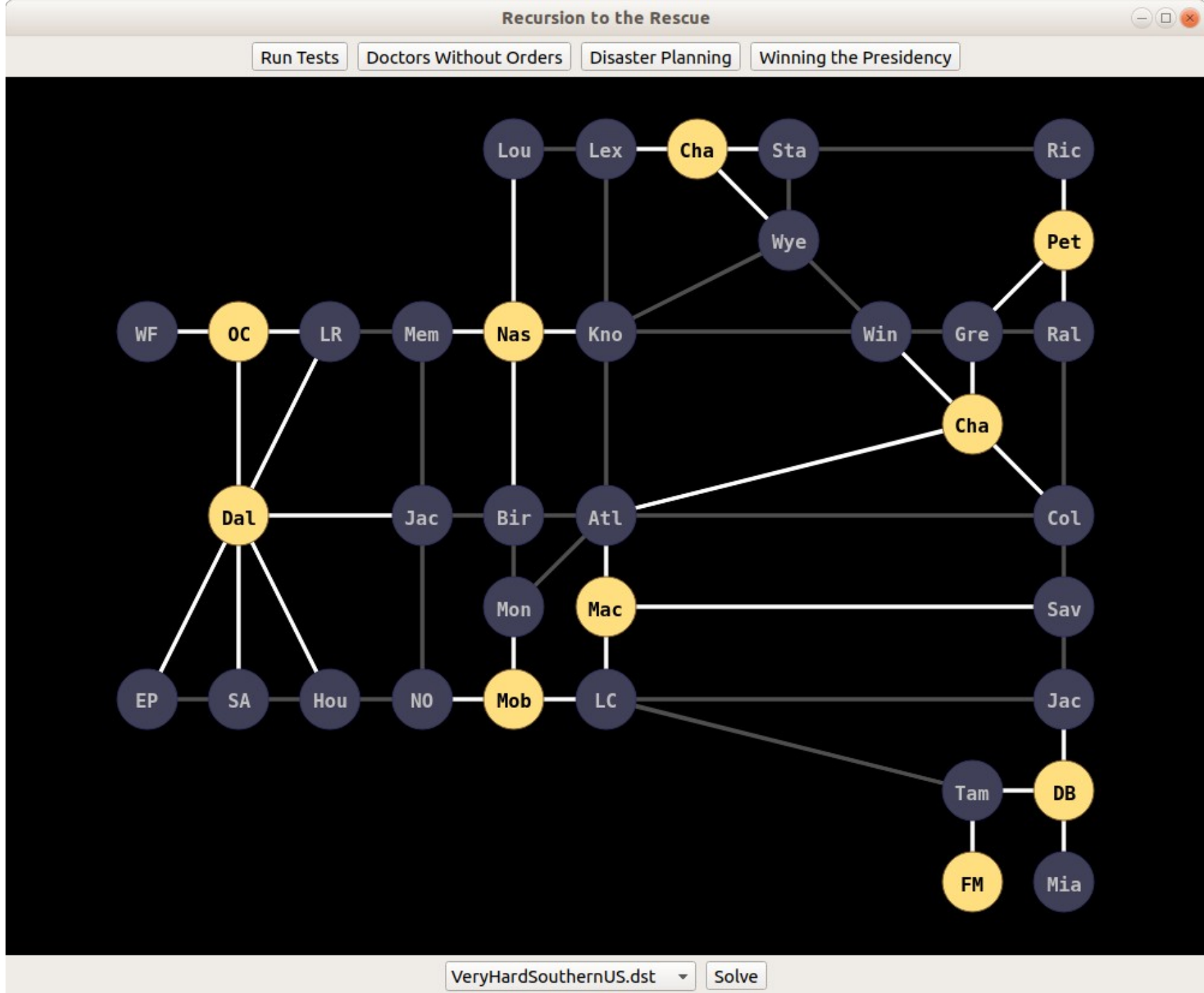

Assignment 4: Recursive Backtracking

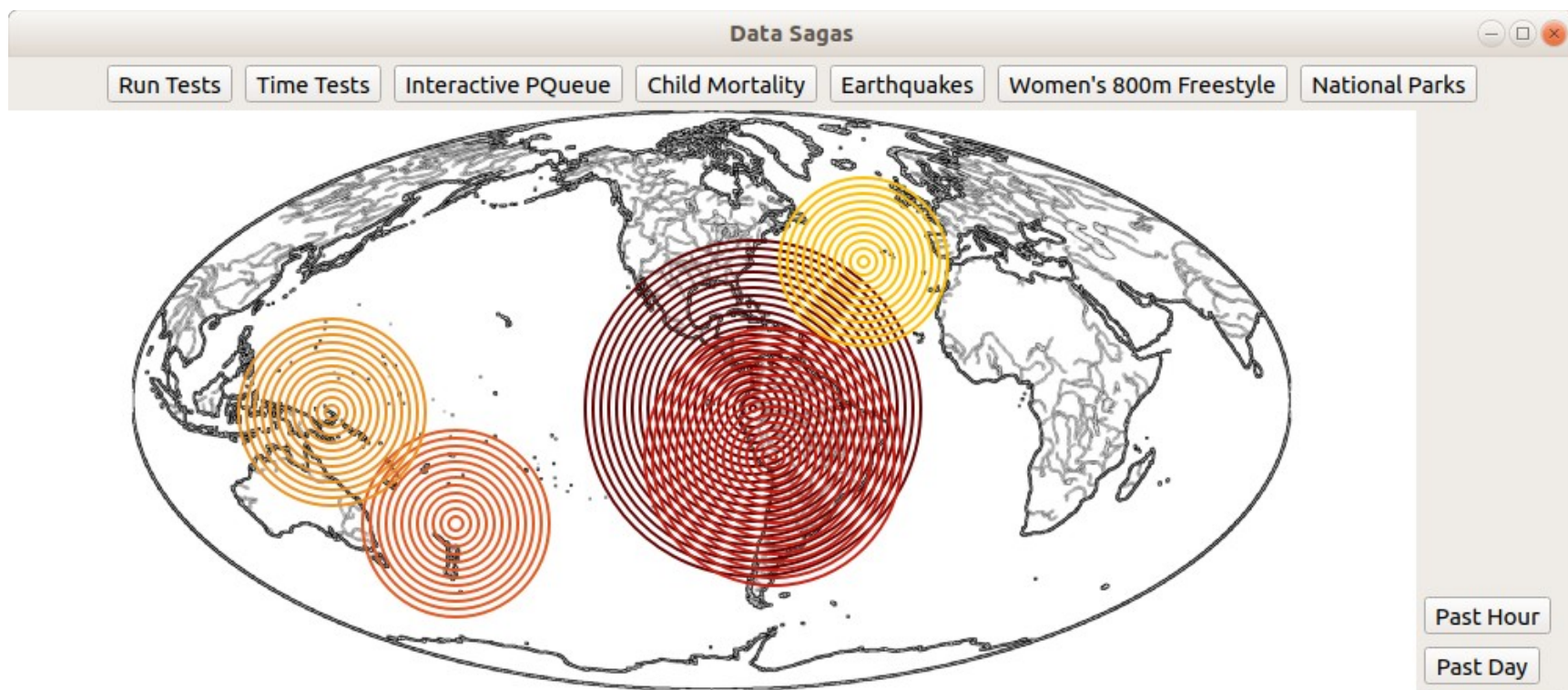

This tool displays the strongest recent earthquakes reported by the US Geological Survey. You can use the controls on the side of the window to select the time interval you're interested in. This visualizer will show the 5 strongest earthquakes within that interval. Remember that the earthquake magnitude scale is logarithmic. An earthquake that is one magnitude in strength higher than another releases around 32 times as much energy.

- Magnitude 7.5 115km ESE of Palora, Ecuador at 02:17:22 AM on Feb 22, 2019
- Magnitude 7 27km NNE of Azangaro, Peru at 12:50:41 AM on Mar 01, 2019
- Magnitude 6.4 116km SE of L'Esperance Rock, New Zealand at 07:46:14 AM on Mar 06, 2019
- Magnitude 6.4 49km NW of Namatanai, Papua New Guinea at 06:35:55 AM on Feb 17, 2019
- Magnitude 6.2 Northern Mid-Atlantic Ridge at 11:57:05 AM on Feb 14, 2019

Assignment 5: Big-O, Sorting, Dynamic Arrays

Article: Sul|



Intersectionality

The term intersectionality

Kimberlé Crenshaw in

analytic framework

systems of power imp

society. Intersectionality

social stratification

age, religion, creed, **disability** and **gender**,

separately from each other but are woven together. While the

theory began as an exploration of the oppression of **women of color**

within society, today the analysis is potentially applied to all

social categories, including social identities usually seen as

dominant when considered independently.

Sulawesi

Suleiman the Magnificent

Sulfate

Sulfuric acid

Sulla

Sultan

Sultanate of Rum

Sulu Sea

feminist scholar

represents an

w interlocking

inalized in

us forms of

sexual orientation,

do not exist

separately from each other but are woven together. While the

theory began as an exploration of the oppression of **women of color**

within society, today the analysis is potentially applied to all

social categories, including social identities usually seen as

dominant when considered independently.

Historical background

The concept of intersectionality is intended to illuminate

dynamic that have often been overlooked by feminist movements and

Assignment 6: Linked Lists, Tries, Binary Search Trees

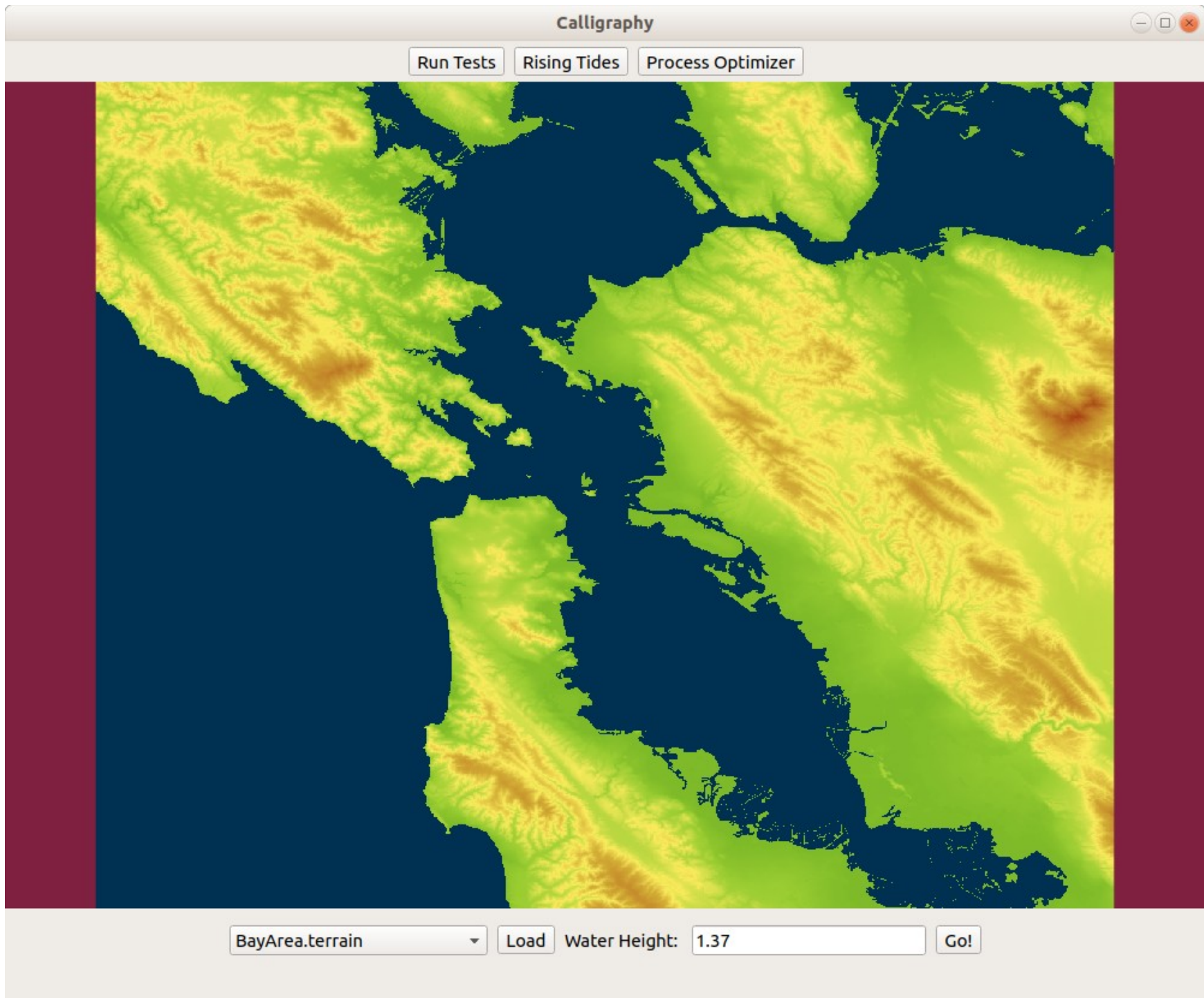

Assignment 7: Graph Algorithms

What We've Covered

Strings

Streams

Recursive Problem-Solving

Stacks

Queues

Vectors

Maps

Sets

Lexicons

What We've Covered

Recursive Graphics

Recursive Enumeration

Recursive Optimization

Recursive Backtracking

Big-O Notation

Insertion Sort

Mergesort

What We've Covered

Designing Abstractions

Constructors

Destructors

Dynamic Arrays

Linked Lists

Binary Search Trees

Tries

Hash Tables

What We've Covered

Graph Representations

Breadth-First Search

Depth-First Search

DAGs

Topological Sorting

Minimum Spanning Trees

Kruskal's Algorithm

But also...

What We've Covered

Chaotic Systems

Language Processing

Physical Simulation

Word Games

What We've Covered

Fractals

Resource Optimization

Operations Research

Data Exploration

***Computer science is more
than just programming.***

***These skills will make you better
at whatever you choose to do.***

So what comes next?

Courses to Take

The CS Core

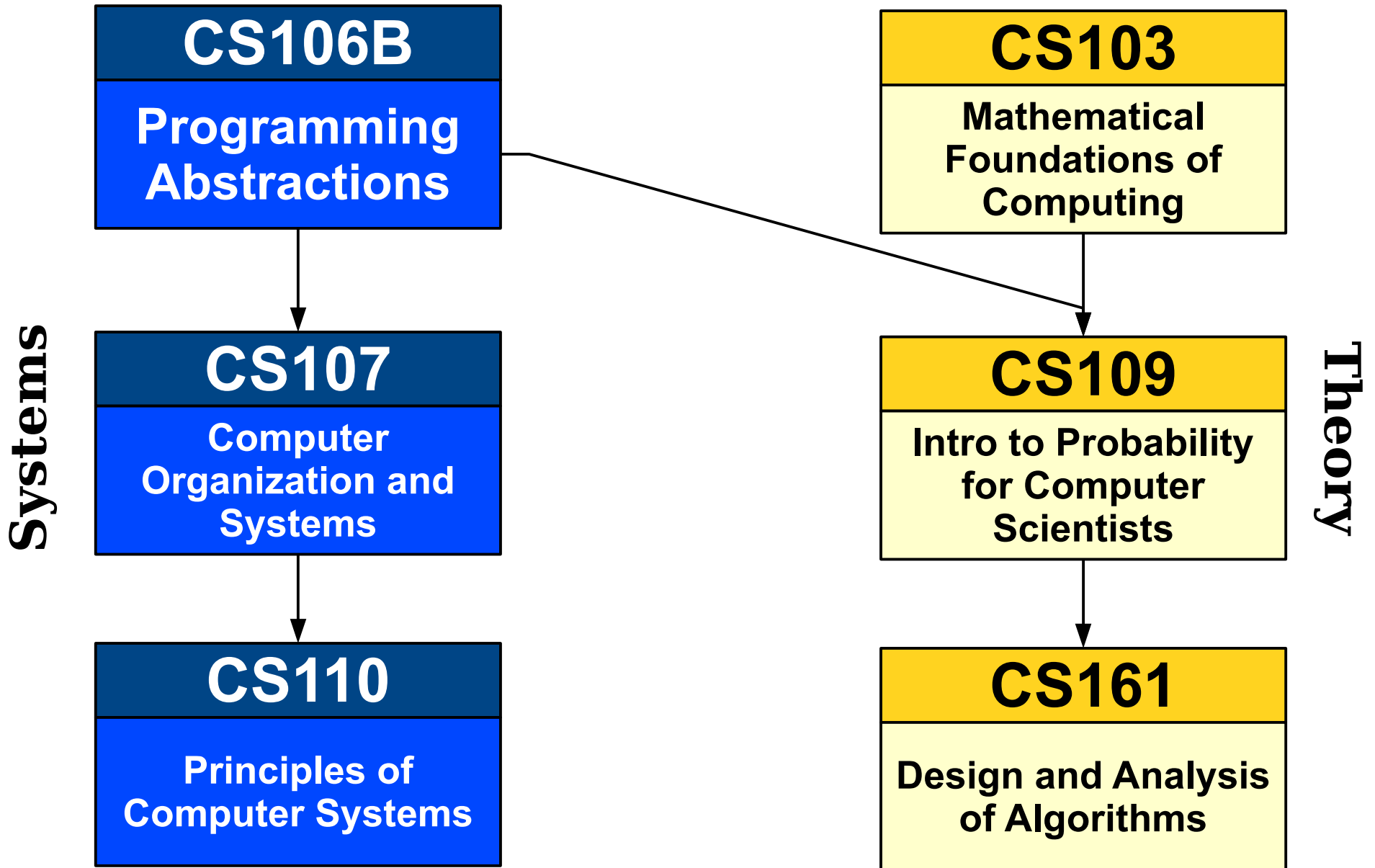

The CS Core

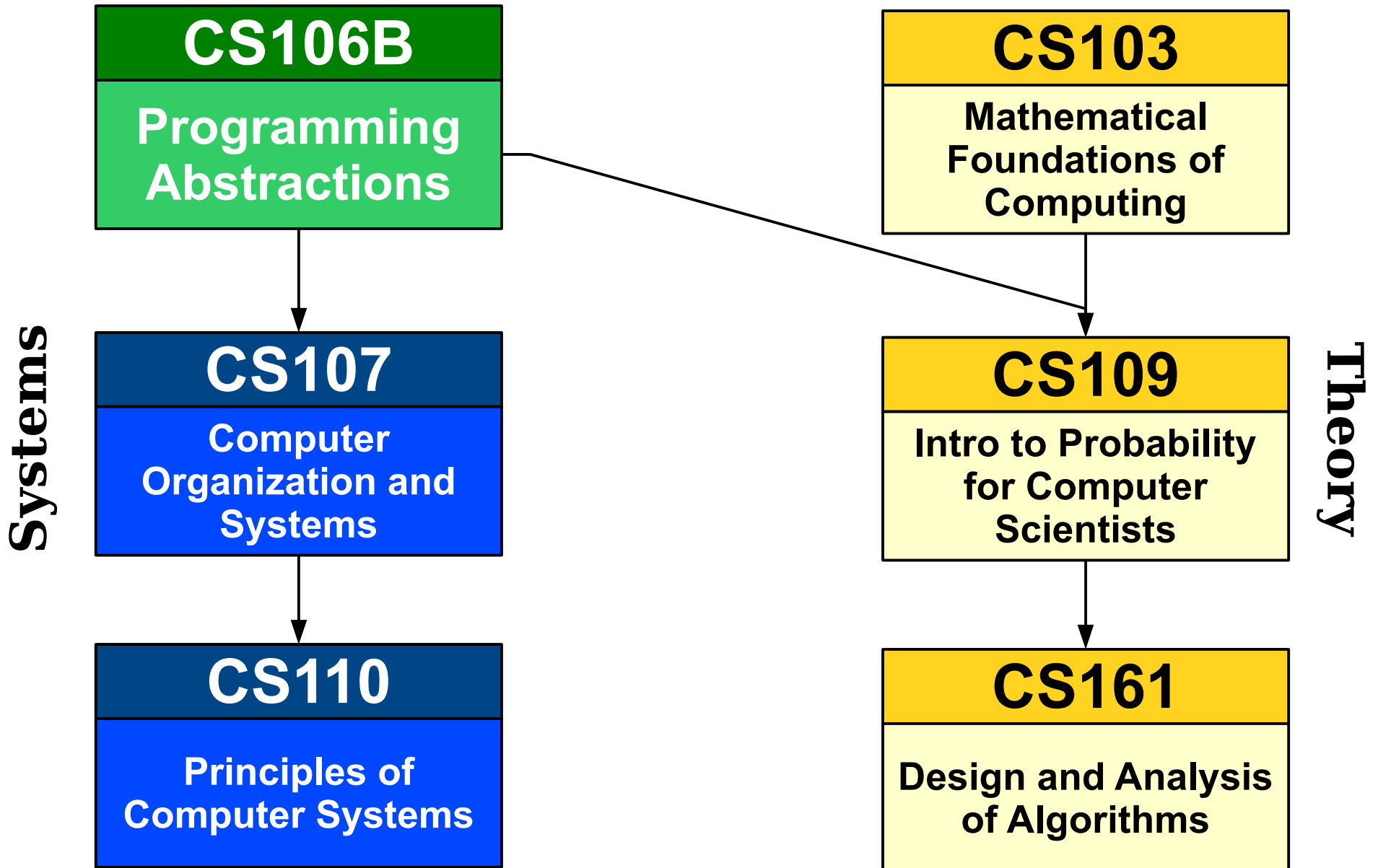

The CS Core

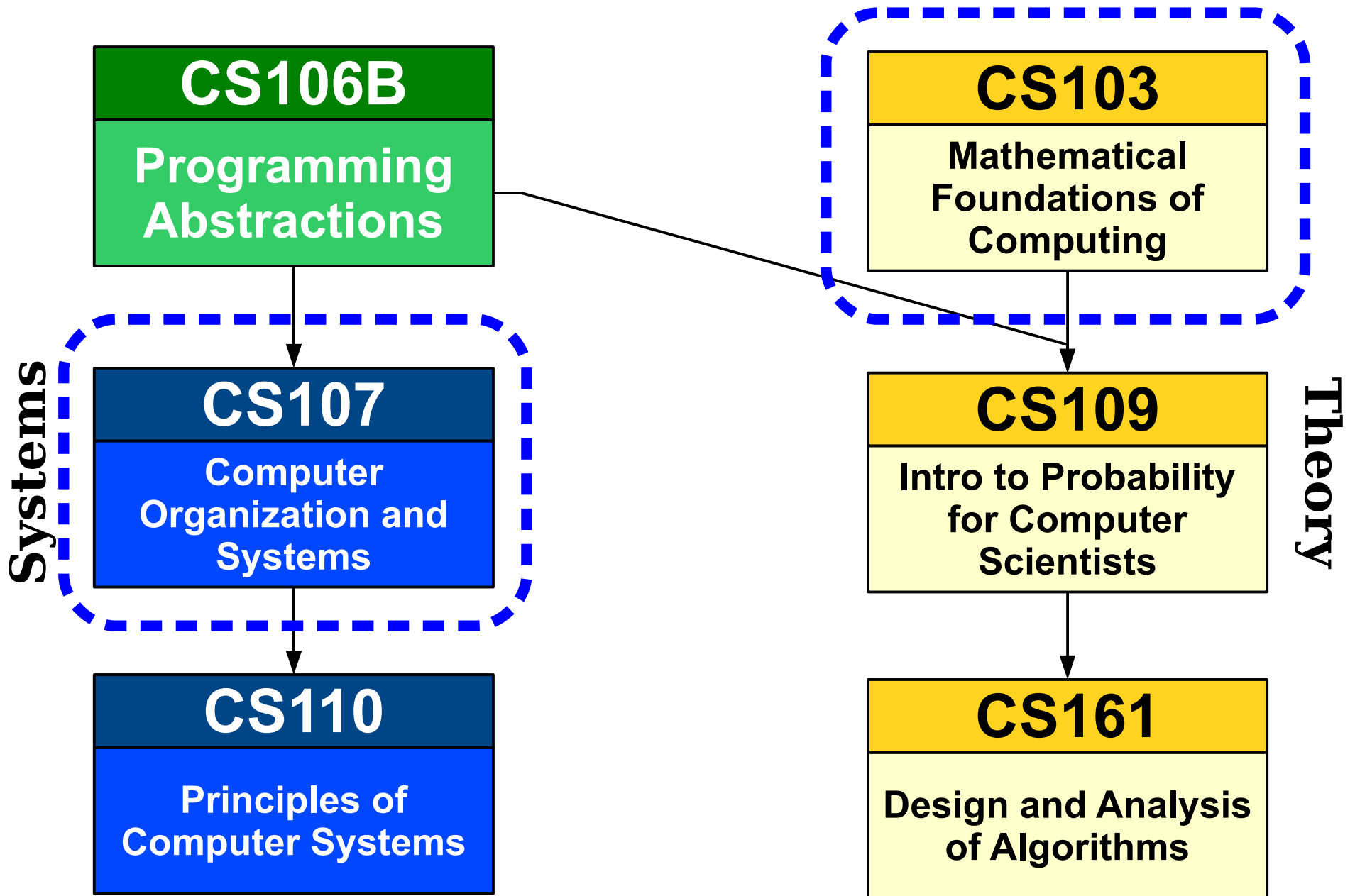

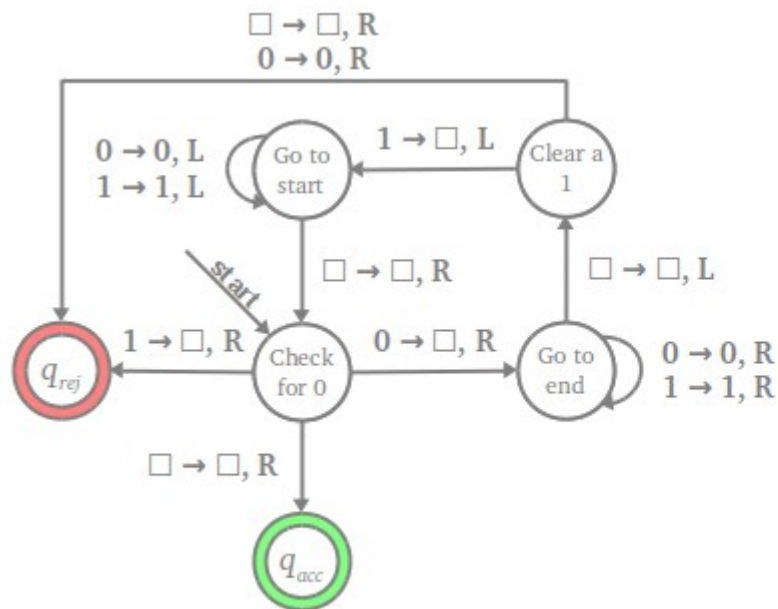

$$\mathcal{L}(M) = \{ 0^n 1^n \mid n \in \mathbb{N} \}$$

CS103

Mathematical Foundations
of Computing

*What are the fundamental limits
of computing power?*

How can we be certain about this?

Some infinities are bigger than other infinities, and this has practical consequences.

Tropes from Ancient Greek mythology can be made mathematically rigorous to prove limits on computing power.

Abstract models of computation have applications in network drivers, user interfaces, compiler design, and text processing.

CS107

Computer Organization and Systems

What is the internal organization of memory in a computer?

How do we bridge the dichotomy between high-level problem-solving and voltages in wires?

And why is this important to know?

The nature of memory layout explains why computer security is so hard to get right.

Computers are physical devices whose inner workings are visible even in higher-level languages.

Compilers can sometimes rewrite recursive functions iteratively, giving you the best of both worlds.

What CS107 Isn't

- CS107 is **not** a litmus test for whether you can be a computer scientist.
 - You can be a *great* computer scientist without enjoying low-level systems programming.
- CS107 is **not** indicative of what programming is “really like.”
 - CS107 does a lot of low-level programming. You don't have to do low-level programming to be a good computer scientist.
- CS107 is **not** soul-crushingly impossibly hard.
 - It's tricky. It does not eat kittens.
- *Don't be afraid to try CS107!*

Other CS Courses

CS193

Programming Language Particulars

- Many offerings throughout the year, focused on specific technologies:
 - CS193A: Android Programming
 - CS193C: Client-Side Web Technologies
 - CS193I: iOS Programming
 - CS193P: iPhone and iPad Programming
 - CS193Q: Accelerated Intro to Python
- Great for learning particular technologies.

CS106L

Standard C++ Programming Lab

- Explore what C++ programming looks like outside of CS106B.
- Get exposure to the standard libraries and some really, really cool techniques beyond what we saw here.
- Excellent next step if you'd like to work in C++ going forward.

CS106E

Practical Exploration of Computing

- Broad survey of computing topics, including
 - how the internet works,
 - computer security,
 - how operating systems work,
 - bits and bytes, and
 - web programming.
- Great course if you're interested in working in the software industry in a non-technical capacity.

CS147

Intro to Human-Computer Interaction

- How do you design software to be usable?
- What are the elements of a good design?
- How do you prototype and test out systems?
- Prerequisite: CS106B! ✓

The CS Major

Thinking about CS?

- Good reasons to think about doing CS:
 - I like the courses and what I'm doing in them.
 - I like the people I'm working with.
 - I like the impact of what I'm doing.
 - I like the community.
- Bad reasons to think about not doing CS:
 - I'm good at this, but other people are even better.
 - The material is fun, but there's nothing philosophically deep about it.
 - I heard you have to pick a track and I don't know what I want to do yet.
 - What if 20 years later I'm just working in a cubicle all day and it's not fun and I have an Existential Crisis?

The CS Major

- A common timetable:
 - Aim to complete *most* of the core by the end of your sophomore year (probably CS106B, CS103, CS107, CS109, and one of CS110 and CS161).
 - Explore different tracks in your junior year and see which one you like the most.
 - Spend your senior year completing it.
- It's okay if you start late!
 - The latest time you can *comfortably* start a CS major would be to take CS106A in winter quarter of sophomore year.
 - And the cotermin is always an option!

The CS Coterm

The CS Coterm

- The CS coterm is open to students of *all majors*, not just computer science.
 - ***This is intentional.*** We want the doors to be open to all comers.
- Thinking about applying?
 - ***Take enough CS classes to establish a track record.***
 - ***Maintain a solid CS GPA.*** Aim high!
- TA and RA positions are available to offset the cost.
 - Some of my best TAs did their undergrad in comparative literature, anthropology, and, physics.

The CS Minor

Outside Stanford

Learning More

- Some cool directions to explore:
 - ***Specific technologies***. You already know how to program. You just need to learn new technologies, frameworks, etc.
 - ***Algorithms***. Learn more about what problems we know how to solve.
 - ***Software engineering***. Crafting big software systems is an art.
 - ***Machine learning***. If no new ML discoveries were made in the next ten years, we'd still see huge improvements.

How to Explore Them

- MOOCs are a great way to get an introduction to more conceptual topics.
 - Andrew Ng's machine learning course, Fei Fei Li's computer vision course, Tim Roughgarden's algorithms course, and Jennifer Widom's databases courses are legendary.
- Learning by doing is the best way to pick up new languages and frameworks.
 - Find a good tutorial (ask around), plan to make a bunch of mistakes, and have fun!
- Know where to ask for help.
 - Stack Overflow is an excellent resource.

Some Words of Thanks

Who's Here Today?

- Aero/Astro
- Anthropology
- Art Practice
- Bioengineering
- Biology
- Business
- Chemical Engineering
- Chemistry
- Civil/Environmental Engineering
- Creative Writing
- Data Science
- East Asian Studies
- Economics
- Education
- Electrical Engineering
- Energy Resources Engineering
- English
- Environmental Systems Engineering
- FemGen
- Genetics
- History
- Human Biology
- Immunology
- International Relations
- Law
- Materials Science
- Mechanical Engineering
- Microbiology and Immunology
- Middle Eastern Languages / Culture
- MS&E
- Physics
- Political Science
- Product Design
- Psychology
- Public Policy
- Spanish
- Statistics
- STS
- Symbolic Systems
- SymSys
- ***Undeclared!***

My Email Address

htiek@cs.stanford.edu

You now have a wide array of tools you can use to solve a huge number of problems.

You have the skills to compare and contrast those solutions.

You have expressive mental models for teasing apart those problems.

My Questions to You:

What problems will you choose to solve?
Why do those problems matter to you?
And how are you going to solve them?